



Rafmagnsvörur

Efnisyfirlit

Aðvörunarljós	Rafhlöðuverkfæri
Afturljós	Raflagnahreinsir
	Rafmagnsvír
Bakkflauta	Rafmagnsmælir
	Rafmagnsspil 12V
Bilanagreinar	Rafmagnstálía
Bílalyftur	
Brýni Fjölnota	Rafmagnsverkfæri
Einangrunarlímbönd	
Ennisljós	Rafmótor
Fjöltengi 230V	
Flautur	Rafsuðuvél
Gaumljós	Realy
Gleröryggi	Realysökkklar
Glitmerki	Rofar
Handljós	Rúðusprautu dælur 12V
Herpihólkar	Samtengi
Hitabyssa	Sandblástursskápar
Hitalampi	Slípirokkur
Hjámiðjurokkur	Smergel
Hliðarljós	Startkaplar
Hnoðbyssa	Starttæki
Höggborvél	Stofnöryggi
Höfuðrofar	Súluborvél
Inniljós	Tengjateikning af 7 og 13 póla tengi
Kapalbönd	Tengibox
Kapalhjól	
Kapalskór	Tengibretti
Kerrutengi	
Leiðsluskór	Vasaljós
Límbyssa	
	Vinnuljós
Loftdæla	
Loftpressa	Víra og skóatangir
Lóðboltar	Víratálía
	Víratengi
Ljósabretti	
Ljósaperur	Víratengjasett
Ljóskastari	
Massavél	Vírbindi
Perur	Þvottakar
Peruskápar	Öryggi
Perustæði	
Póluskór	Öryggjahús
Prufulampi	
Rafeinagrun	Öryggjasett
Rafgeymar	
Rafgeymavörn	Öryggjatöng
Rafhlöður	





Bílaperur

FRAMLIÓS

H1 PERUR

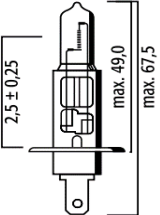
H1 PERUR Á SPJALDI

 	093 3021 12V 55W P14,5s	093 3021130 12V 55W P14,5s
	H1 Pessi venjulega	H1 ULTRA + 130%
	093 3021333 12V 55W P14,5s	
	H1 Megablue	
	093 3021300 12V 55W P14,5s	093 93021 12V 55W P14,5s
	H1 Ultra White 4200°K + 30%	H1 Pessi venjulega
	093 3021900 12V 55W P14,5s	
	H1 Ultra + 90%	093 93021900 12V 55W P14,5s
	093 3021180 12V 55W P14,5s	H1 Ultra + 90%
	H1 Ultra + 90% Twinbox	
093 3021335 12V 70W P14,5s		
H2 PERUR		
093 3024 24V 70W P14,5s	093 3420 12V 55W X511	
H1 Pessi venjulega	55W Pessi venjulega	
093 302499 24V 70W P14,5s	093 13420 12V 100W X511	
H1 HD	100W Rally	
093 13024 24V 100W P14,5s	093 3720 24V 70W X511	
H1 Rally	70W Pessi venjulega	

FRAMLIÓS

H3 PERUR

H3 PERUR Á SPJALDI

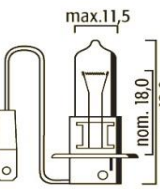
	093 3320 12V 55W PK22s	093 93320 12V 55W PK22s
	H3 Pessi venjulega	H3 Pessi venjulega
	093 3320333 12V 55W PK22s	
	H3 Megablue	
093 3320900 12V 55W PK22s		
H3 Ultra + 90%		
093 3324 24V 100W PK22s	093 13324 24V 100W PK22s	
H3 Pessi venjulega	H3 Rally	

FRAMLIÓS

H4 PERUR

H4 PERUR Á SPJALDI

 	093 625543 12V 60/55W P43t	093 9625543 12V 60/55W P43t
	H4 Pessi venjulega	H4 Pessi venjulega
	093 625522 12V 60/55W P43t	
	H4 Longlife	
	093 6255333 12V 60/55W P43t	093 9725543 12V 100/90W P43t
	H4 Megablue	H4 Rally
	093 6230043 12V 60/55W P43t	
	H4 Ultra white 4200°k + 30%	
	093 6255600 12V 60/55W P43t	093 96290043 12V 60/55W P43t
	H4 Ultra white 4200°k twinbox	H4 Ultra +90%
093 6289043 12V 60/55W P43t		
H4 Megaplux 50%		
093 6290043 12V 60/55W P43t		
H4 Ultra + 90%		
093 6213043 12V 60/55W P43t		
H4 Ultra + 130%		
093 525543 12V 100/55W P43t		
H4 Rally		
093 7255335 12V 100/90W P43t		
H4 Silverblue		

FRAMLJÓŚ
H4 PERUR
H4 PERUR

	093 825522 24V 75/70W P43t H4 VR LL Vibration Resistant & Longlife
	093 825543 24V 75/70W P43t H4 Pessi venjulega
	093 8290043 24V 100/90W P43t H4 Rally

	093 625545 12V 60/55W P45t H4 Hringlött gamla gerðin.
	093 825545 24V 75/70W P45t H4 Hringlött gamla gerðin.
	093 8213043 24V 130/90W P43t H4 Super Rally

FRAMLJÓŚ
H7 PERUR
H7 PERUR Á SPJALDI

	093 2070 12V 55W PX26d H7 Pessi venjulega
	093 207022 12V 55W PX26d H7 Longlife
	093 2070900 12V 55W PX26d H7 Ultra + 90%
	093 2070100 12V 55W PX26d H7 Ultra + 100%
	093 2070130 12V 55W PX26d H7 Ultra + 130%
	093 2070333 12V 55W PX26d H7 Megablue
	093 2070300 12V 55W PX26d H7 Ultra White 4200°K + 30 %
	093 12070 12V 80W PX26d H7 Rally
	093 2470 24V 70W PX26d H7 Pessi venjulega
	093 247022 24V 70W PX26d Longlife, Vibration Resistant

	093 92070 12V 55W PX26d H7 Pessi venjulega
	093 92070900 12V 55W PX26d H7 Ultra + 90%



FRAMLJÓŚ
H8 - H9 - H10 PERUR
H11 - PERUR

	093 2080 12V 35W PGJ19-1 35W Pessi venjulega H8
	093 92080 12V 35W PGJ19-1 Pessi pera er í blister pakkningu
	093 2090 12V 65W PGJ19-5 65W Pessi venjulega H9
	093 9145 12V 42W PY20d 42W Pessi venjulega H10

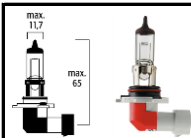
	093 2110 12V 55W PGJ119-2 55W Pessi venjulega H11
	093 92110 12V 55W PGJ119-2 Pessi pera er í blister pakkningu
	093 2114 24V 70W PGJ119-2 70W Pessi venjulega H11

FRAMLIJÓS
H12 PERUR

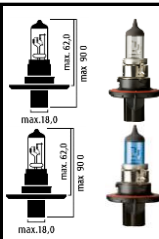
093 9055 **12V** 53W PZ20d
53W Pessi venjulega H12

H13 PERUR

093 9008 **12V** 60/55W P26,4t
60/55W Pessi venjulega H13

093 9008333 **12V** 60/55W P26,4t
60/5W Blá

FRAMLIJÓS
H15 PERUR

093 551523 **12V** 55/15 PGJ23T-1
55/15W Pessi venjulega H15

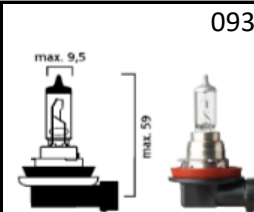
H16 PERUR

093 191219 **12V** 19W PGJ19-3
19W H16 Longlife

1987302089 BOSCH Númer

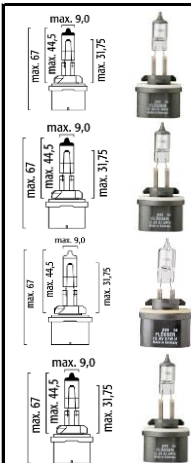

FRAMLIJÓS
H27W/1 PERUR

093 880 **12V** 27W PG13
27W Pessi venjulega 9mm

093 893 **12V** 37,5W PG13
37,5W Pessi venjulega 9mm

093 890 **12V** 27W PG13
27W Pessi venjulega 9mm
Ekki með svartri hettu

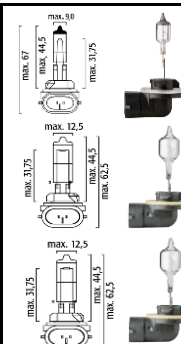
093 885 **12V** 50W PG13
50W Pessi venjulega

H27W/2 PERUR

093 881 **12V** 27W PGJ13
27W Pessi venjulega 9mm

093 886 **12V** 50W PGJ13
50W Pessi venjulega 12,5mm

093 894 **12V** 37,5W PGJ13
37,5W Pessi venjulega 12,5mm

FRAMLIJÓS
HB1 PERUR

093 9004 **12V** 65/45W P29t
65/45W Pessi venjulega

093 9004333 **12V** 65/45W P29t
65/45W Blá

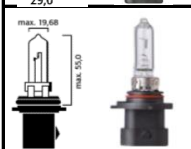

HB3A PERUR
093 9005XS **12V** 60W PX20D
60W Pessi venjulega

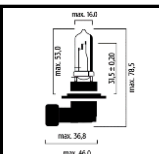
HB3 PERUR

093 9005 **12V** 60W P20d
60W Pessi venjulega

093 9005333 **12V** 60W P20d
60W Megablue

093 9005900 **12V** 60W P20d
60W ULTRA +90%

093 99005 **12V** 60W P20d
Pessi pera er í blisterpakkingu

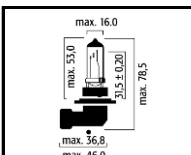
FRAMLIJÓS
HB4 PERUR

093 9006 **12V** 51W P22d
51W Pessi venjulega

093 9006333 **12V** 51W P22d
51W Megablue

093 9006XS **12V** 51W P22d
51W Bein festing.

093 9006900 **12V** 51W P22d
Ultra + 90%

093 99006900 **12V** 51W P22d
Ultra + 90% blister pakking

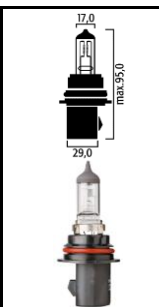

HB5 PERUR

093 9007 **12V** 65/55W PX29t
65/55W Pessi venjulega

093 9007333 **12V** 65/55W PX29t
65/55W Blá

FRAMLIÓS
HIR2 PERUR
R2 PERUR

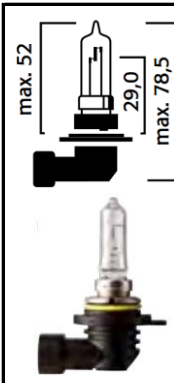
093 9012 **12V** 55W PX22d
55W Þessi venjulega



max. 52
29,0
max. 78,5

093 3940 **12V** 45/40W P45t
45/40W Þessi venjulega

093 3770 **24V** 55/50W P45t
55/50W Þessi venjulega



max. 41,0
nom. 28,5

FRAMLIÓS
P13
Kastarapera
FRAMLIÓS
HS1
Fjór hjól

093 69672133 **12V** 13W PG18,5-d1
13W Kastarapera P13W



max 16,6
max 44
max 18,5

093 323543 **12V** 35/35W PX43t
35/35W Þessi venjulega



nom. 28,5
max. 92,0

FRAMLIÓS
XENON D1S PERUR
XENON D2R PERUR

093 85410 **85V** 35W Pk32d-2
35W Þessi venjulega 4200°K

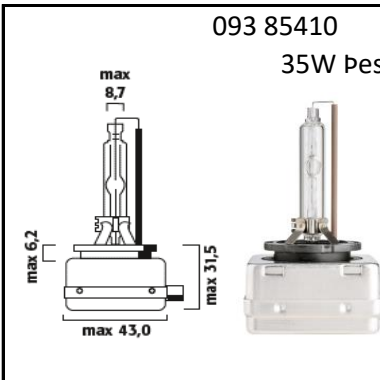

max 8,7
max 6,2
max 31,5
max 43,0

093 85426 **85V** 35W P32d-3
35W Þessi venjulega 4200°K

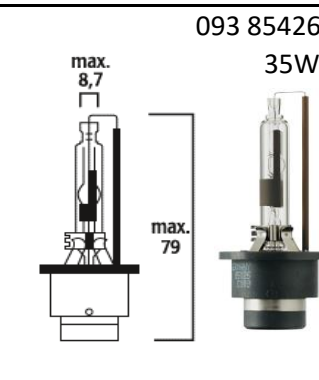

max 8,7
max 79

FRAMLIÓS
XENON D2S PERUR
XENON D3S PERUR

093 85422 **85V** 35W P32d-2
35W Þessi venjulega 4200°K



max 8,7
max 79

093 42322 **42V** 35W PK32d-5
35W Þessi venjulega



max. 8,0
max. 58,0
max. 83,0
max. 44,0

093 42422 **42V** 35W P32d-5
35W Þessi venjulega



max 8,7
max 79

FRAMLIÓS
LÍTIL FRAMLIÓSAPERA

093 1251 **12V** 25/25W P15d-25-1
25/25W

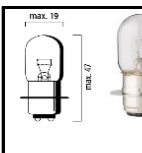

max. 19
max. 67

Mótorhjólaperá.

093 24540 **12V** 45/40W BA20d
45/40W

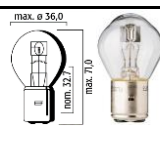

max. ø 36,0
max. 7,0
nom. 32,7

Tveggja póla perá.

1 PÓLA PERUR 6,8 mm

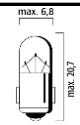
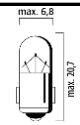
	093 4051 12V 2W BA7s
	2W Þessi venjulega
	093 4048 24V 3W BA7s
	3W Þessi venjulega

1 PÓLA PERUR 8,8 mm

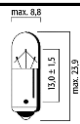
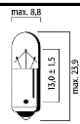
	093 4038 12V 2W BA9s
	2W Þessi venjulega
	093 4008 24V 2W BA9s
	2W Þessi venjulega

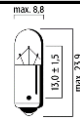
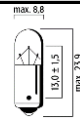
	093 4088 12V 4W BA9s
	4W Þessi venjulega
	093 4080 24V 4W BA9s
	4W Þessi venjulega

1 PÓLA PERUR 8,8 mm

	093 94088 12V 4W BA9s
	4W Þessi venjulega á spjalði
	2 stk

1 PÓLA PERUR 9mm

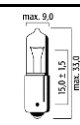
	093 4010 12V 10W BA9s
	10W Þessi venjulega

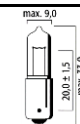
	093 6021 12V 21W BAY9s
	21W Þessi venjulega H21W

1 PÓLA PERUR 9mm

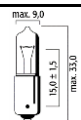
	093 4006 12V 6W BAX9s
	6W Þessi venjulega H6W

1 PÓLA PERUR 12,2mm

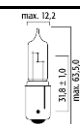
	093 795X 12V 50W BA15s
	50W Þessi venjulega halogen

1 PÓLA PERUR 19mm

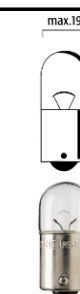
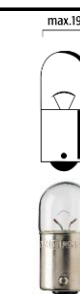
	093 4025 12V 5W BA15s
	5W Þessi venjulega
	093 4052 24V 5W BA15s
	5W Þessi venjulega
	093 405299 24V 5W BA15s
	5W Heavy Duty

1 PÓLA PERUR Á SPJALDI

	093 94025 12V 5W BA15s
	5W Þessi venjulega
	2 stk

	093 14025 12V 10W BA15s
	10W Þessi venjulega R10W
	093 14052 24V 10W BA15s
	10W Þessi venjulega R10W
	093 1405299 24V 10W BA15s
	10W Heavy Duty R10W
	093 1402501 12V 10W BAU15s
	10W Gul á litinn Amber RY10W
	093 1402507 12V 10W BA15s
	10W Gul á litinn Amber

	093 914025 12V 10W BA15s
	10W Þessi venjulega R10W
	2 stk

1 PÓLA PERUR 25,5mm

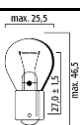
	093 5671 12V 15W BA15s
	15W Þessi venjulega

1 PÓLA PERUR 26,5mm

1 PÓLA PERUR Á SPJALDI

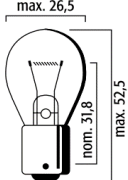

093 6671 **12V** 21W BA15S
P21W Pessi venjulega

093 6652 **24V** 21W BA15S
P21W Pessi venjulega

093 665299 **24V** 21W BA15S
P21W Heavy Duty

093 665207 **24V** 21W BA15S
P21W Amber Gul á litinn

093 667101 **12V** 21W BAU15S
PY21W Amber gul á litinn
Misvísandi pinnar

093 667107 **12V** 21W BA15S
Amber gul á litinn
Beinir pinnar



093 96671 **12V** 21W BA15S
P21W Pessi venjulega
2 stk



093 9667101 **12V** 21W BAU15S
PY21W Amber gul á litinn
2 stk Misvísandi pinnar.

1 PÓLA PERUR 36mm

1 PÓLA PERUR 18,5mm

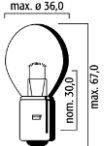

093 3350 **12V** 50W BA20s
50W Pessi venjulega

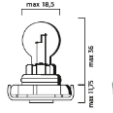
093 6968433 **12V** 24W PG20/4
24W Amber gul á litinn



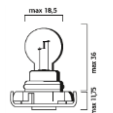

093 69676933 **12V** 24W PG20/7
24W



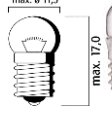

1 PÓLA PERUR SKRÚFAÐAR 11,5mm

1 PÓLA PERUR SKRÚFAÐAR 11,5mm



093 4045 **12V** 3W E10
3W Pessi venjulega





093 4046 **24V** 3W E10
3W Pessi venjulega

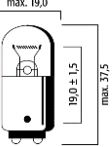

2 PÓLA PERUR 19mm

2 PÓLA PERUR 26,5mm



093 4452 **24V** 5W BA15d
5W Pessi venjulega

093 14425 **12V** 10W BA15d
10W Pessi venjulega

093 14452 **24V** 10W BA15d
10W Pessi venjulega

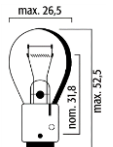
093 5329 **12V** 21/4W BAZ15d
P21/4W Pessi venjulega
Misvísandi pinnar



093 5339 **24V** 21/4W BAZ15d
P21/4W Pessi venjulega
Misvísandi pinnar

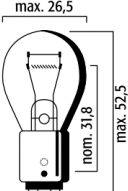

2 PÓLA PERUR 26,5mm

2 PÓLA PERUR Á SPJALDI



093 5229 **12V** 21/5W BAY15d
P21/5W Pessi venjulega

093 522907 **12V** 21/5W BAY15d
P21/5W Amber Gul á litinn

093 5239 **24V** 21/5W BAY15d
P21/5W Pessi venjulega



093 95229 **12V** 21/5W BAY15d
P21/5W Pessi venjulega
2 stk

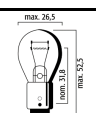

093 5228 **6V** 21/5W BAY15d
P21/5W Pessi venjulega

2 PÓLA PERUR 26,5mm

2 PÓLA PERUR 26,5mm

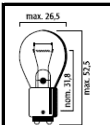

093 5238 **24V** 21/5W BA15d

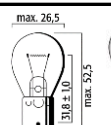

093 6674 **12V** 21W BA15d
21W Þessi venjulega

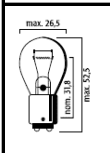

093 522902 **12V** 21/5W BAW15D
21/5W Rauð á litinn.

2 PÓLA PERUR 36,0mm



093 3939 **12V** 35/35W BA20d
P35/35W Þessi venjulega

USA 2 PÓLA STUNGUPEUR

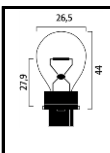

093 3156 **12V** 27W W2,5X16d
27W Þessi venjulega USA

USA 2 PÓLA STUNGUPEUR

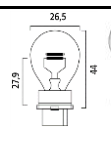

093 3157 **12V** 27/7W
27/7W Þessi venjul. W2,5X16q

USA 1 PÓLA STUNGUPERA

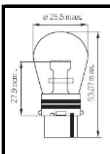

093 503156A **12V** 32W W2,5X16d
32W Þessi venjulega
Gul á litinn

093 315601 **12V** 32W W2,5X16d

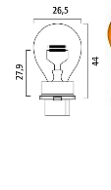

093 315701 **12V** 27/7W
27/7W Þessi venjul. WX2,5X16q
Gul á litinn

USA 2 PÓLA STUNGUPERA

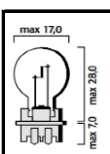

093 39202933 **12V** 24W
24W Þessi venjulega PWY24W
WP3,3X14,5/4
Gul á litinn

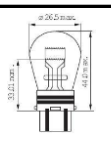

093 503157A **12V** 32/3W
32/3W Þessi venjul. W2,5X16q
Gul á litinn 32/3CP

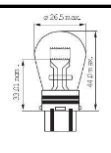

093 503357A **12V** 40/3W
40/3W Þessi venjul. W2,5X16q
Gul á litinn 40/3CP

STUNGUPERA 2PINNAR

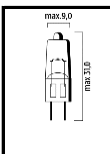

093 2074205 **12V** 5W G4
5W Þessi venjulega 9mm

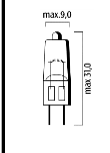

093 2074210 **12V** 10W G4
10W Þessi venjulega 9mm

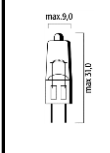

093 2074220 **12V** 20W G4
20W Þessi venjulega 9mm

STUNGUPERA 2PINNAR

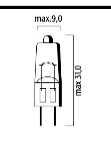

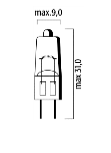

093 2074410 **24V** 10W G4
10W Þessi venjulega 9mm



093 2074420 **24V** 20W G4
20W Þessi venjulega 9mm

Fleiri perugerðir eru fáanlegar en sýndar eru.

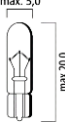
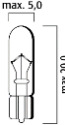
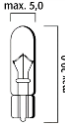
STUNGUPERA 5 mm
STUNGUPERA 5 mm

	093 4191	12V	1,2W	W2x4,6d
			1,2W Pessi venjulega T5	
	093 419106	12V	1,2W	W2x4,6d
			1,2W Mött T5	
	093 4391	12V	2W	W2x4,6d
			2W Pessi venjulega T5	
	093 4192	24V	1,2W	W2x4,6d
			1,2W Pessi venjulega T5	

	093 94191	12V	1,2W	W2x4,6d
			1,2W Pessi venjulega á spjaldi 2 stk	



HETTUR FYRIR T5 PERUR

	093 60021	Hetta f/peru Blá
	093 60022	Hetta f/peru Græn
	093 60023	Hetta f/peru Rauð
	093 60024	Hetta f/peru Gul
	093 60025	Hetta f/peru Orange

STUNGUPERA 7 mm

	093 4591	12V	3W	W2x4,6d
			3W Pessi venjulega	

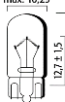
STUNGUPERA 10,29 mm
STUNGUPERA 10,29 mm

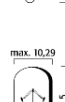
	093 4290	12V	2W	T10
			2W Pessi venjulega W2,1x9,5d	
	093 4090	12V	3W	T10
			3W Pessi venjulega W2,1x9,5d	
	093 4092	24V	3W	T10
			3W Pessi venjulega W2,1x9,5d	
	093 4291	12V	5W	T10
			5W Pessi venjulega W2,1x9,5d	



	093 94291	12V	5W	T10
			5W Pessi venjulega W2,1x9,5d 2 stk	
	093 4292	24V	5W	T10
			5W Pessi venjulega W2,1x9,5d	
	093 429101	12W	5W	T10
			5W Pessi venjulega W2,1x9,5d Gul á litinn	

HETTUR FYRIR T10 PERUR
HETTUR FYRIR T10 PERUR

	093 60001	Hetta f/peru blá		093 60004	Hetta f/peru Gul
	093 60002	Hetta f/peru græn		093 60005	Hetta f/peru Orange
	093 60003	Hetta f/peru rauð			

STUNGUPERA 13,5 mm
STUNGUPERA 15,7 mm

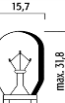
	093 4490	12V	10W	W2,1x9,5d
			10W Pessi venjulega W2,1x9,5d	

	093 921	12V	16W	W2,1x9,5d
			16W Pessi venjulega W2,1x9,5d	
	093 92107	12W	16W	W2,1x9,5d
			16W Pessi venjulega Gul á lit	

STUNGUPERA 20,5 mm
STUNGUPERA 20,5 mm

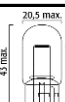
	093 2190	12V	21W	W3x16d
			21W Pessi venjulega W3x16d	

	093 219007	12V	21W	W3x16d
			21W Pessi venjulega W3x16d Gul á litinn	

STUNGUPERA 20,5 mm 2.PÓLA
STUNGUPERA 20,5 mm 2.PÓLA

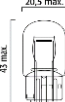
	093 2690	12V	21/5W	W3x16Q
			21/5W Pessi venjulega W3x16Q	

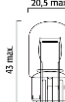
	093 269007	12V	21/5W	W3x16Q
			21/5W Pessi venjulega W3x16Q Gul á litinn	

5 mm STUNGUPERA Í HÚSI
5 mm STUNGUPERA Í HÚSI

		093 419101 1,2W	12V 1,2W Svart hús	B8,5d			093 449101 1,2W	12V 1,2W Ljósblátt hús	BX8,5d
		093 459101 1,5W	12V 1,5W Gult hús	BX8,5d			093 439101 2W	12V 2W Grænt hús	B8,5d
		093 479101 2W	12V 2W Ljósgrænt hús	BX8,5d			093 419201 1,2W	24V 1,2W Grátt hús	B8,5d
		093 419102 1,2W	12V 1,2W Svart hús	B8,3d			093 439102 2W	12V 2W Hvítt hús	B8,3d
		093 449103 1,1W	12V 1,1W Appelsínugult hús	BX8,4d			093 419103 1,2W	12V 1,2W Svart hús	BX8,4d
		093 479103 1,3W	12V 1,3W Olívugrænt hús	BX8,4d			093 459103 1,5W	12V 1,5W Beige hús	BX8,4d
		093 439103 2W	12V 2W Grænt hús	BX8,4d					
		093 449105 1,4W	14V 1,4W Svart hús	HRQ			093 183385 1,8W	12V 1,8W Gænt hús	EBS R11
		093 501399 1,2W	24V 1,2W Svart hús Bosma				093 502494K 1,2W	24V 1,2W Brúnt hús Bosma	



PERUSETT
093 80200 PERUKASSI 12V. MÆLABORD



6924	10stk	459101	10stk
449103	10stk	459103	10stk
419101	10stk	183385	5stk
419102	10stk	439101	10stk
419103	10stk	439102	10stk
449101	10stk	439103	10stk
6925	10stk	479101	10stk
479103	10stk	409080	2stk
449105	5stk	4591	10stk





Fleiri perugerðir eru fáanlegar en sýndar eru.

PULSUPERA 6,2mm
PULSUPERA 8mm





		093 5148	12V 3W	SV5,5
		3W	6,2x28mm	
		093 5149	24V 3W	SV5,5
		3W	6,2x28mm	

		093 5159	24V 3W	SV7
		3W	8x28mm	

PULSUPERA 10mm

		093 5168	12V 10W	SV8,5
		10W	10x28mm	

PULSUPERA 11mm

		093 4033	12V 5W	SV8,5
		5W	11x35mm	
		093 4002	24V 5W	SV8,5
		5W	11x35mm	
		093 403310	12V 10W	SV8,5
		10W	11x35mm	





PULSUPERA 11mm

		093 4230	12V 5W	SV8,5
		5W	11x40mm	
		093 4206	24V 5W	SV8,5
		5W	11x40mm	
		093 4231	12V 10W	SV8,5
		10W	11x40mm	





2stk á Blister pakkingu.

PULSUPERA 15mm

		093 400418	12V 18W	SV8,5
		18W	15x41mm	
		093 4215	24V 15W	SV8,5
		15W	15x41mm	

SÉRHÆFD PULSUPERA 10mm

		093 561	12,8V 12CP	
		12CP	Rigid Loop	



LED PERUR 1 PÓLA

		093 914020	12-24V	BA15s
		Hvítur litur	18x36mm	
		093 916670	12V	BA15s
		Hvítur litur	26,5x50mm	



LED PERUR 1 PÓLA

		093 914028	12-24V	BA15s
		Rauður litur	18x36mm	
		093 916677	12V	BA15s
		Glær litur	26,5x50mm	



LED PERUR 2 PÓLA

		093 915220	12V	BAY15d
		Hvítur litur	26,5x50mm	



LED PULSUPERA

		093 914030	12-24V	SV8,5
		Hvítur litur	13,5x38mm	













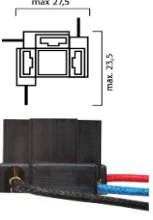



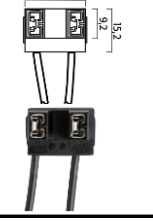

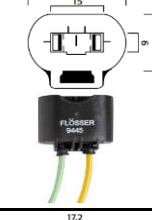

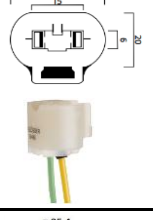

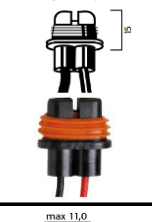
LED STUNGUPERA

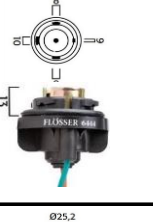
		093 914290	12-24V	W2,1x9,5d
		Hvítur litur	W5W	

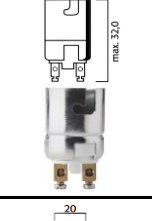
LED STUNGUPERA

		093 914293	12-24V	W2,1x9,5d
		Blár litur	W5W	

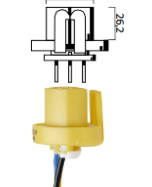
Fleiri perugerðir eru fánlegar en sýndar eru.

 <p>PERUSTÆÐI H4 093 4444 Perustæði H4 Fyrir kapal 2,5mm²</p> 	 <p>PERUSTÆÐI H4 093 4445 Perustæði H4 Með kapli</p> 
 <p>PERUSTÆÐI H4 093 4446 Perustæði H4 Keramik með kapli</p> 	 <p>PERUSTÆÐI H7 093 7444 Perustæði H7 Með kapli</p> 
 <p>PERUSTÆÐI HB3, H10, H12, HIR1 093 9445 Perustæði HB3 Með kapli H10, H12, HIR1</p> 	 <p>PERUSTÆÐI HB4, HIR2 093 9446 Perustæði HB4, HIR2 Með kapli</p> 
 <p>PERUSTÆÐI H8, H9, H11 093 9448 Perustæði H8, H9 Með kapli H11</p> 	 <p>PERUSTÆÐI BA15s 093 6444 Perustæði BA15s Með kapli</p> 
 <p>PERUSTÆÐI BAY15d 093 6447 Perustæði BAY15d Járn hús</p> 	 <p>PERUSTÆÐI BAY15d 093 5444 Perustæði BAY15d Með kapli</p> 
 <p>PERUSTÆÐI HB1 093 9444 Perustæði HB1 Með kapli 2,5mm²</p> 	

PERUSKÁPUR FLÖSSER



093 18900 Peruskápur



Lítill skápur

SPÆÐAÖRYGGI 9,1MM

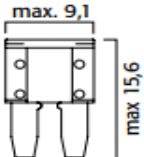
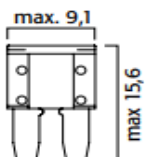
SPÆÐAÖRYGGI 9,1MM





	093 502805	32V	Ljósbrúnt		093 502820	32V	Gult	
		32V	5 Amp				32V	20 Amp
	093 502875	32V	Brúnt			093 502825	32V	Hvít
		32V	7,5 Amp				32V	25 Amp
	093 502810	32V	Rautt			093 502830	32V	Grænt
		32V	10 Amp				32V	30 Amp
	093 502815	32V	Ljósblátt					
	32V	15 Amp						

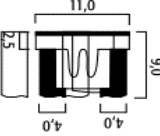
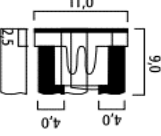

JAPAN

SPÆÐAÖRYGGI 11 MM

SPÆÐAÖRYGGI 11MM

	093 503802	58V	Grátt		093 513800	58V			
		58V	2 Amp						
	093 503803	58V	Fjólublátt						
		58V	3 Amp						
	093 503804	58V	Bleikt						
		58V	4 Amp						
	093 503805	58V	Ljósbrúnt						
		58V	5 Amp						
	093 503875	58V	Brúnt						
		58V	7,5 Amp						
	093 503810	58V	Rautt						
	58V	10 Amp							
	093 503815	58V	Ljósblátt						
	58V	15 Amp							
	093 503820	58V	Gult						
	58V	20 Amp							
	093 503825	58V	Hvít						
	58V	25 Amp							
	093 503830	58V	Grænt						
	58V	30 Amp							

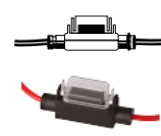







093 6308 Öryggjahús
Japan

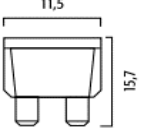
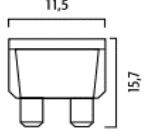

SPÆÐAÖRYGGI 11,5 MM

SPÆÐAÖRYGGI 11,5 MM

	093 514802	32V	Grátt		093 514800	32V			
		32V	2 Amp						
	093 514803	32V	Fjólublátt						
		32V	3 Amp						
	093 514804	32V	Bleikt						
		32V	4 Amp						
	093 514805	32V	Ljósbrúnt						
		32V	5 Amp						
	093 514875	32V	Brúnt						
		32V	7,5 Amp						
	093 514810	32V	Rautt						
	32V	10 Amp							
	093 514815	32V	Ljósblátt						
	32V	15 Amp							
	093 514820	32V	Gult						
	32V	20 Amp							
	093 514825	32V	Hvít						
	32V	25 Amp							
	093 514830	32V	Grænn						
	32V	30 Amp							

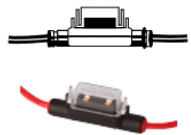

093 6307 Öryggjahús



ÖRYGGJABOX

ÖRYGGJABOX

093 213020 Öryggjabox Japan
11mm
Japan 100stk



066 BCF100 Öryggjabox
11,5mm Mini 100stk



093 213010 Öryggjabox spaða
11,5 mm Mini 100stk



SPAÐAÖRYGGI 19MM

SPAÐAÖRYGGI 19MM

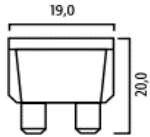

093 214801	32V	Svart
32V	1 Amp	
093 214802	32V	Grátt
32V	2 Amp	
093 214803	32V	Fjólublátt
32V	3 Amp	
093 214804	32V	Bleikt
32V	4 Amp	
093 214805	32V	Ljósbrúnt
32V	5 Amp	
093 214875	32V	Brúnn
32V	7,5 Amp	
093 214810	32V	Rautt
32V	10 Amp	
093 214815	32V	Ljósblátt
32V	15 Amp	
093 214820	32V	Gult
32V	20 Amp	
093 214825	32V	Hvítt
32V	25 Amp	
093 214830	32V	Ljósgrænt
32V	30 Amp	
093 214840	32V	Orange
32V	40 Amp	

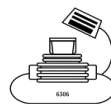
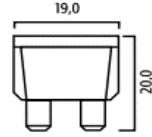

093 6306 Öryggjahús



066 BCF120 Öryggjabox 19mm
120stk



ÖRYGGJASETT BLANDAÐ

093 213050 Öryggjasett blandað 140stk

Öryggi 11,5mm		
514875	7,5A	10stk
514810	10A	10stk
514815	15A	10stk
514820	20A	10stk
514825	25A	10stk
514830	30A	10stk

Öryggi 19mm

214805	5A	10stk
214875	7,5A	10stk
214810	10A	10stk
214815	15A	10stk
214820	20A	10stk
214825	25A	10stk
214830	30A	10stk



Öryggi 30mm

314820	20A	2stk
314830	30A	2stk
314840	40A	2stk



Öryggi 30mm

314850	50A	2stk
314860	60A	2stk



ÖRYGGJASETT 19MM

093 213040 Öryggjasett 19mm 110stk



214801	1A	5stk	214815	15A	10stk
214802	2A	5stk	214820	20A	10stk
214803	3A	10stk	214825	25A	10stk
214804	4A	10stk	214830	30A	10stk
214805	5A	10stk	214840	40A	10stk
214875	7,5A	10stk	16552		1stk
214810	10A	10stk			



SPAÐAÖRYGGI 30MM

SPAÐAÖRYGGI 30MM SETT

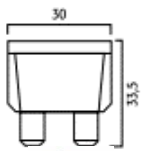

093 314820	32V	Gult
32V	20 Amp	
093 314825	32V	Grátt
32V	25 Amp	
093 314830	32V	Grænt
32V	30 Amp	
093 314840	32V	Orange
32V	40 Amp	
093 314850	32V	Rautt
32V	50 Amp	
093 314860	32V	Ljósblátt
32V	60 Amp	
093 314870	32V	Brúnn
32V	70 Amp	
093 314880	32V	Hvítt
32V	80 Amp	
093 3148100	32V	Fjólublátt
32V	100 Amp	



066 BCF36 Öryggjabox Sett
Maxi 36stk



093 324800 Öryggjahús f/ Maxi



093 324822 Hlíf yfir Öryggjahús

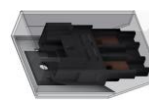

093 324844 Öryggjahús með hlíf



093 213070 Öryggjabox blandað 446 stk



Öryggi 11mm Japan

503802	2A	5stk
503803	3A	5stk
503804	4A	5stk
503805	5A	10stk
503875	7,5A	15stk
503810	10A	20stk
503815	15A	20stk
503820	20A	20stk
503825	25A	15stk
503830	30A	15stk



Öryggi 11,5mm

514803	3A	5stk
514805	5A	5stk
514875	7,5A	5stk
514810	10A	20stk
514815	15A	20stk
514820	20A	20stk
514825	25A	15stk
514830	30A	20stk



Öryggi 19mm

214805	5A	10stk
214875	7,5A	10stk
214810	10A	30stk
214815	15A	30stk
214820	20A	20stk
214825	25A	20stk
214830	30A	20stk
214840	40A	5stk







Öryggi 30mm

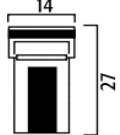

314820	20A	8stk
314830	30A	8stk
314840	40A	8stk
314850	50A	8stk
314860	60A	8stk
314870	70A	8stk
314880	80A	8stk
3148100	100A	5stk



ÖRYGGI 14MM - TYPE J

    	093 609020	32V	Blátt
		32V	20 Amp
	093 609025	32V	Ljós grátt
		32V	25 Amp
	093 609030	32V	Bleikt
		32V	30 Amp
	093 609040	32V	Grænt
	32V	40 Amp	
093 609050	32V	Rautt	
	32V	50 Amp	
093 609060	32V	Gult	
	32V	60 Amp	

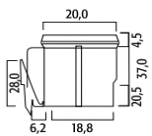



ÖRYGGI 20MM - TYPE E

 	093 609545	32V	Rautt
		32V	45 Amp
	093 609565	32V	Svart
		32V	65 Amp
093 609575	32V	Grátt	
	32V	75 Amp	



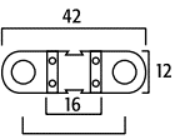

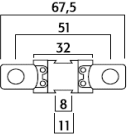

ÖRYGGI AFLÖNG - TYPE C

    	093 607030	32V	Bleikt
		32V	30 Amp
	093 607040	32V	Gænt
		32V	40 Amp
	093 607050	32V	Rautt
		32V	50 Amp
	093 607060	32V	Gult
		32V	60 Amp
	093 607080	32V	Svart
		32V	80 Amp
	093 6070100	32V	Blátt
		32V	100 Amp
093 6070120	32V	Hvítt	
	32V	120 Amp	

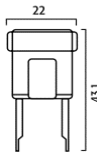



STOFNÖRYGGI

 	093 7048030	58V	Orange
		58V	30 Amp
	093 7048040	58V	Grænt
		58V	40 Amp
	093 7048050	58V	Rautt
	58V	50 Amp	
	093 7048060	58V	Gult
		58V	60 Amp
	093 7048070	58V	Brúnt
	58V	70 Amp	
 	093 8048080	32V	Rautt
		32V	80 Amp
	093 8048100	32V	Gult
	32V	100 Amp	





ÖRYGGI 22MM - TYPE B

     	093 604830	32V	Bleikt
		32V	30 Amp
	093 604840	32V	Grænt
		32V	40 Amp
	093 604850	32V	Rautt
		32V	50 Amp
	093 604860	32V	Gult
		32V	60 Amp
	093 604870	32V	Brúnt
		32V	70 Amp
093 604880	32V	Svart	
	32V	80 Amp	
093 604900	32V	Blátt	
	32V	100 Amp	
093 604920	32V	Hvítt	
	32V	120 Amp	

ÖRYGGI 22MM - TYPE AS

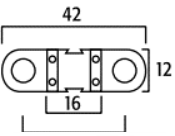
   	093 605020	32V	Blátt
		32V	20 Amp
	093 605030	32V	Bleikt
		32V	30 Amp
	093 605040	32V	Grænt
		32V	40 Amp
093 605050	32V	Rautt	
	32V	50 Amp	
093 605060	32V	Gult	
	32V	60 Amp	

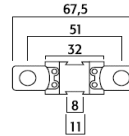
STOFNÖRYGGI

 	093 7048080	58V	Hvítt
		58V	80 Amp
	093 7048100	58V	Blátt
		58V	100 Amp
	093 7048150	58V	Grátt
	58V	150 Amp	
	093 724800	Öryggjahús fyrir 7048 línuna	
 	093 8048150	32V	Orange
		32V	150 Amp
	093 8048300	32V	Grátt
	32V	300 Amp	

ÖRYGGJAHÚS

ÖRYGGJAHÚS



482 307024-S Öryggjahús 4 stykkja
Fyrir 19mm spaðaöryggi



482 307026-S Öryggjahús 6 stykkja
Fyrir 19mm spaðaöryggi



482 307028-S Öryggjahús 8 stykkja
Fyrir 19mm spaðaöryggi



GLERÖRYGGI 5mm

GLERÖRYGGI 5mm

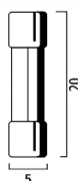

093 1014005	32V	5x20mm
32V	0,5 Amp	
093 1014010	32V	5x20mm
32V	1 Amp	
093 1014012	32V	5x20mm
32V	1,25 Amp	
093 1014016	32V	5x20mm
32V	1,6 Amp	
093 1014020	32V	5x20mm
32V	2 Amp	
093 1014025	32V	5x20mm
32V	2,5 Amp	



093 1014031	32V	5x20mm
32V	3,15 Amp	
093 1014040	32V	5x20mm
32V	4 Amp	
093 1014050	32V	5x20mm
32V	5 Amp	
093 1014063	32V	5x20mm
32V	6,3 Amp	
093 1014100	32V	5x20mm
32V	10 Amp	



GLERÖRYGGI 6,3mm

GLERÖRYGGI 6,3mm

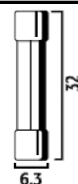

093 3201	32V	6,3X32mm
32V	1 Amp	
093 830105	32V	6,3X32mm
32V	2,5 Amp	
093 3203	32V	6,3X32mm
32V	3 Amp	
093 3204	32V	6,3X32mm
32V	4 Amp	
093 3205	32V	6,3X32mm
32V	5 Amp	
093 3210	32V	6,3X32mm
32V	10 Amp	

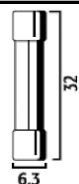

093 3215	32V	6,3X32mm
32V	15 Amp	
093 3220	32V	6,3X32mm
32V	20 Amp	
093 3225	32V	6,3X32mm
32V	25 Amp	
093 3230	32V	6,3X32mm
32V	30 Amp	
093 3240	32V	6,3X32mm
32V	40 Amp	



KERAMÍK ÖRYGGI

KERAMÍK ÖRYGGI

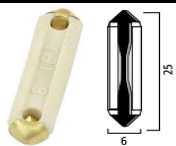

093 114805	32V	Gult
32V	5 Amp	
093 124808	32V	Hvítt
32V	8 Amp	

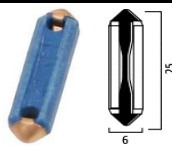

093 114816	32V	Rautt
32V	16 Amp	
093 124825	32V	Blátt
36V	25 Amp	

STÓR ÖRYGGI

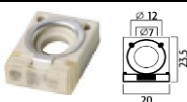

093 9048150	58V	
58V	150 Amp	

RELAY 4 PINNA

RELAY 4 PINNA

093 2142 **12V**
12V 30 Amp

093 2248 **12V**
12V 50 Amp

093 2270 **12V**
12V 70 Amp

093 2275 **24V**
24V 70 Amp

093 4242 **24V**
24V 20Amp

RELAY 5 PINNA

RELAY SÖKKLAR

093 2252 **12V**
12V 30 Amp

093 1123 Relay sökkull "Mini"

093 2222 Relay sökkull

093 2262 **12V**
12V 20/30 Amp

093 2268 **12V**
12V 30/40 Amp

093 2162 **12V**
12V 20/30 Amp

093 4254 **24V**
24V 30 Amp

093 4162 **24V**
24V 10/20 Amp

ÖRYGGI FYRIR VÉLAR

ÖRYGGI FYRIR VÉLAR

093 38040 Öryggi
32V 40 Amp

093 38050 Öryggi
32V 50 Amp

093 39040 Öryggi
32V 40 Amp

093 39050 Öryggi
32V 50 Amp

FLAUTA 12V

FLAUTA 24V

093 123359 **12V** 91mm
12V 340 Hz

093 243359 **24V** 91mm
24V 340Hz

FLAUTA 12V

BAKKFLAUTA

093 124309 **12V** 91mm
12V 430 Hz

093 128097 **12-80V**
12V-80V 97dB

KLÓ Í KVEIKJARA

MILLISTYKKI F/USB SNÚRU

093 181420 **12V-24V**
12V-24V

093 181740 Input : 12-24V
Output: 5,0 V

4800mA
2x USB-A
1x USB-C

482 303010-K Kló í kveikjara og í tengi
12V

482 303006 Innstunga í gat
18mm

470 114120 Sökull fyrir 12V kló með spaðatengi
18mm

MERIT MALTA

482 303007-K Innstunga m/loki
18mm

482 303001 Kló í tengi minni gerðin

482 303008 Innstunga utaná skrúfuð

482 302008 Starthnappur 12V

482 302009 Starthnappur 12V

470 201700 Starthnappur 12V með spaðatengi

MERIT MALTA

GAUMLJÓS

ROFAR



482 302110 12V og 24V
Gauumljós Gult 12V Gat 17mm
12V pera BA9s 2W fylgir
(Pera 24V er 093 4080)



482 302111 12V og 24V
Gauumljós Grænt 12V Gat 17mm
12V pera BA9s 2W fylgir
(Pera 24V er 093 4080)



482 302112 12V og 24V
Gauumljós Blátt 12V Gat 17 mm
12V pera BA9s 2W fylgir
(Pera 24V er 093 4080)



482 302113 12V og 24V
Gauumljós Rautt 12V Gat 17 mm
12V pera BA9s 2W fylgir
(Pera 24V er 093 4080)



482 302101
Rofi Grænn Út/inn 12Volt



482 302102
Rofi Blár Út/Inn 12Volt



482 302103
Rofi Rauður Út/Inn 12Volt



482 302104
Rofi Gulur Út/Inn 12Volt



VELTIROFAR

VELTIROFAR



482 302011
Rofi velti 19x13mm On/Off



482 302012
Rofi velti svartur 20mm



482 302012-B
Rofi Blár velti 20mm



482 302012-G
Rofi Grænn velti 20mm



482 302012-O
Rofi Gulur velti 20mm



482 302012-R
Rofi Rauður velti 20mm



482 302010 Rofi m/toggormi og krók



470 210720 Rofi útdreginn 12V með spaðatengi





470 206520 Hurðarofi 12V með spaðatengi





066 BT98/11 Ampermælir 0-75AH













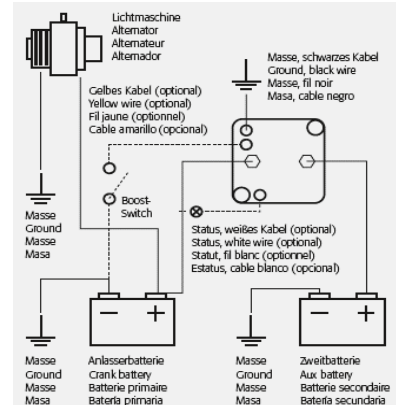







093 9458

Fyrir rafgeyma

Hleðslustýring 12V fyrir rafg.





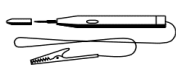

	<p>470 216001 Rofi "on/off" stuttur með spaðatengi</p> <p>MERIT MALTA</p>	 <p>482 302001 Rofi "on/off" 20A með spaðatengi</p> <p>Fyrir 12mm gat.</p> 
	<p>482 302003 Rofi "on/off/on" 20A með spaðatengi</p> <p>Fyrir 12mm gat.</p> 	 <p>482 302119 Rofi "on/off" fyrir skó með gati</p> <p>Fyrir 12mm gat.</p>
	<p>482 302001-B Rofi "on/off" blár með spaðatengi</p> <p>Fyrir 12mm gat.</p> 	 <p>482 302001-G Rofi "on/off" grænn með spaðatengi</p> <p>Fyrir 12mm gat.</p> 
	<p>482 302001-0 Rofi "on/off" orange með spaðaengi</p> <p>Fyrir 12mm gat.</p> 	 <p>482 302001-R Rofi "on/off" rauður með spaðatengi</p> <p>Fyrir 12mm gat.</p> 

	<p>470 327550 Sviss M/starti 12V 0-1-2-Start 2 lyklar</p> <p>Operating Temp -30C - +80C Storage Temp -40C - +90C Terminals DIN 46 244 - A6, 3 x 0.8</p> <p>MERIT MALTA</p>	 <p>482 302018 Sviss M.F.2 lyklar 0-1-2-3 0-1-2-3 2 lyklar</p> 
	<p>580 S41288 Sviss M/hitara MF/ IH * Massey Ferguson MF35, 100,135,165</p> 	

	<p>470 328605 Höfuðrofi 400Ah 12V 25qm</p> <p>MERIT MALTA</p>	 <p>470 328700 Höfuðrofi 2500Ah 24V</p> <p>MERIT MALTA</p>
---	--	--

PRUFULAMPI
PERUPRUFARI



093 183044 Prufulampi 6V-24V
6V-24V
093 5149 Auka pera í profara



093 183000 Peruprufari
Rotpfeil





482 402004 Prufulampi 6V-24V
6V-24V 110mm



066 AK4008 Leiðnimælir
6V-24V

066 CFT1 Öryggjaprufari



066 AK415 Leiðnimælir Led
3V-28V

066 AK2252 Afeinangrunartöng
1, 1.6, 2, 2.6, 3.2mm²
175mm



066 AK2266 Afeinangrunartöng
Víraklippur





066 AK7945 Verkfærasett
fyrir rafmagnsbíla
polir 1000V



RAFLAGNAHREINSIVÖRUR
RAFLAGNAHREINSIVÖRUR

048 090505 Raflagnahreinsir
Contact cleaner 500ml
Efnið er til hreinslunar á rafmangsnertum og tengjum ýmiskonar. Efnið heldur vel frá raka og drullu. Fyrir bifreiðar, mótórhjól og fl.



048 090108 Rafeinangrun
Purrkspray
Electro protect 500ml
Efnið er notað til að þurrka raflagnir. Smýgur vel inn í alla staði. Efnið heldur vætu og raka vel frá. Góð viðloðun, góð vörn.



048 090515 DPF Hreinsir 500ml
Skynjarahreinsir
Öflugur hreinsir fyrir sótagnasíur.



048 090516 EGR Hreinsir 500ml
Skynjarahreinsir
Efnið er fljótvirkt hreinsiefni fyrir útblástursloftunarloka, EGR loka.



























048 090408 Rykhreinsir sprej
fyrir rafbúnað
500ml
Fjarlægir ryk og óhreinindi
Ekki eldfimt og notendavænt
Þrýstiloft í spreibrúsa



048 090103 Kapalvörn spray
500ml
Fælir frá mýs og önnur nagdýr sem vilja naga rafmagnsleiðslurnar.



Einangraðir leiðsluskór			Rauðir	Vírsverleiki 0,5 - 1,5mm ²
	482 305001	Kapalskór rauður Gat 3mm		482 305004 Kapalskór rauður 066 RT11 Sívalur Hann 4mm
	482 305002 066 RT24	Kapalskór rauður Gat 4mm		482 305005 Kapalskór rauður 066 RT23 Sívalur Hún 4mm
	482 305003 066 RT25	Kapalskór rauður Gat 5mm		066 RT29 Kapalskór rauður 100stk í pk. Samtengi 4mm
	482 305015 066 RT26	Kapalskór rauður Gat 6mm		482 305007 Kapalskór rauður 066 RT19 Hún 2,8mm
	482 305016 066 RT27	Kapalskór rauður Gat 8mm		482 305008 Kapalskór rauður 066 RT20 Hún 4,8mm
	482 305017	Kapalskór rauður Gat 10mm		482 305009 Kapalskór rauður 066 RT21 Hún 6,3mm
	482 305021 066 RT13	Kapalskór rauður Opinn 3mm		066 RT16 Kapalskór rauður Hún lokað 6,3mm
	482 305018 066 RT14	Kapalskór rauður Opinn 4mm		482 305011 Kapalskór rauður 066 RT10 Hann 2,8mm
	482 305014 066 RT18	Kapalskór rauður Pinni 1,9mm		482 305020 Kapalskór rauður Hann 4,8mm
	482 305030	Kapaltengi rauður Herpihólkur 4 mm		066 RT22 Kapalskór rauður Hann 6,3mm
	066 RTSPF25 6,4mm	Kapaltengi rauður Hún Herpihólkur		482 305013 Kapalskór rauður 066 RT17 Tvöfaldur 6,3mm
	066 RTSPM25 6,3mm	Kapalskór rauður Hann Herpihólkur		482 307050 Þjófateggi rautt 066 QSPR 0,5-1,0mm
	066 RTSSB25	Samtengi 22-18 AWG Með lóðningu		

KRÓNUTENGI 12 STK LENGJUR

482 307040
Raftengi Svart Lengja 4mq



482 307042
Raftengi Svart Lengja 10mq































KRÓNUTENGI 12 STK LENGJUR





















482 307041
Raftengi Svart Lengja 6mq



482 307047
Raftengi Hvít Lengja 10mq



Einangraðir leiðsluskór			Bláir	Vírsverleiki 1,5 - 2,5mm ²	
	482 305101	Kapalskór blár Gat 3mm		482 305105	Kapalskór blár Sívalur Hann 4mm
	482 305102	Kapalskór blár 066 BT24 Gat 4mm		482 305106	Kapalskór blár 066 BT11 Sívalur Hann 5mm
	482 305103	Kapalskór blár 066 BT25 Gat 5mm		482 305107	Kapalskór blár Sívalur Hún 4mm
	482 350104	Kapalskór blár 066 BT26 Gat 6mm		482 305108	Kapalskór blár 066 BT22 Sívalur Hún 5mm
	482 305120	Kapalskór blár 066 BT27 Gat 8mm		066 BT12	Kapalskór blár Samtengi 4,5mm
	482 305127	Kapalskór blár 066 BT23 Gat 10,5mm		482 305113	Kapalskór blár 066 BT19 Hún 4,8mm
	482 305123	Kapalskór blár 066 BT13 Opinn 4mm		482 305115	Kapalskór blár 066 BT20 Hún 6,3mm
	482 305109	Kapalskór blár Opinn 4mm		482 305118	Kapalskór blár Hún 7,7mm
	482 305110	Kapalskór blár 066 BT14 Opinn 5mm		482 305129	Kapalskór blár 066 BT15 Hún lokuð 4,8mm
	482 305119	Kapalskór blár 564 Pinni 1,9mm		482 305116	Kapalskór blár 066 BT16 Hún lokuð 6,3mm
	482 305122	Kapalskór blár 621 066 BT18 Pinni 1,9mm		482 305126	Kapalskór blár Hann 4,8mm
	482 305130	Kapalskór blár Herpihólkur 5,8mm		482 305114	Kapalskór blár 066 BT21 Hann 6,3mm
	482 307051	Pjófategi blátt 066 QSPB 1,5-2,5mm		066 BTSSB25	Samtengi með lóðningu blá
	482 305117	Kapalskór blár 066 BT17 Tvöfaldur 6,3mm		066 BTSPM25	Herpihólkur blár Hann 6,4mm 25stk

Einangraðir leiðsluskór			Gulir	Vírsverleiki 4,0 - 6,0mm ²	
	482 305201	Kapalskór gulir Gat 4mm		482 305211	Kapalskór gulir 066 YT21 Sívalur Hann 5mm
	482 305222	Kapalskór gulir 066 YT18 Gat 5mm		482 305212	Kapalskór gulir Sívalur Hún 5mm
	482 305218	Kapalskór gulir 066 YT19 Gat 8mm		482 305213	Kapalskór gulir 066 YT10 Samtengi 5,5mm
	482 305204	Kapalskór gulir 066 YT20 Gat 8mm		482 305215	Kapalskór gulir 066 YT13 Hún 6,3mm
	482 305219	Kapalskór gulir 066 YT16 Gat 10mm		482 305216	Kapalskór gulir 066 YT14 Hún 9,5mm
	482 305205	Kapalskór gulir 066 YT17 Gat 13mm		066 YT11	Kapalskór gulir Hún lokuð 6,3mm
	482 305207	Kapalskór gulir Opinn 5mm		482 305214	Kapalskór gulir 066 YT15 Hann 6,3mm
	482 305208	Kapalskór gulir Opinn 6mm		066 YTSSB25	Samtengi með lóðningu gult
	482 305217	Kapalskór gulir 066 YT23 Pinni 2,9mm		482 305230	Kapalskór gulir Herpihólkur 6,8mm
	482 307052	Pjófategi gult 4,0-6,0mm		066 WTSSB25	Samtengi með lóðningu hvít

Kapalskóasett

066 AB038MT Kapalskór Sett
Gul/rauð/blá 200stk



AB038MT
Blue; Bullet; Ø5mm (x10), Butt Connector; Ø4.5mm (x30), Easy-Entry Ring; Ø8.4mm (5/16") (x10), Female Socket; Ø5mm (x10), Fully Insulated Female; 6.3mm (x10), Push-On Female; 6.3mm (x10), Push-On Male; 6.3mm (x10), Red; Bullet; Ø4mm (x10), Butt Connector; Ø3.3mm (x20), Female Socket; Ø4mm (x10), Fully Insulated Female; 6.3mm (x10), Push-On Female; 2.8mm (x10), Push-On Male; 6.3mm (x10), Yellow; Butt Connector; Ø5.5mm (x20), Easy-Entry Ring; Ø6.4mm (1/4") (x10), Ø8.4mm (5/16") (x10)



Kapalskóasett

066 AB039RT Kapalskór Sett
Rauðir 260 stk



AB039RT
Bullet; Ø4mm (x30), Butt Connector; Ø3.3mm (x30), Easy-Entry Fork; Ø3.7mm (4BA) (x10), Ø5.3mm (2BA) (x10), Easy-Entry Pin; 12mm x Ø1.9mm (x10), Easy-Entry Ring; Ø5.3mm (2BA) (x10), Ø8.4mm (5/16") (x10), Female Socket; Ø4mm (x20), Fully Insulated Female; 4.7mm (x20), 6.3mm (x10), Piggy-Back; 6.3mm (x20), Push-On Female; 2.8mm (x20), 4.8mm (x20), 6.3mm (x20), Push-On Male; 6.3mm (x20)



066 AB040BT Kapalskór Sett
Bláir 280 stk



AB040BT
Bullet; Ø5mm (x35), Butt Connector; Ø4.5mm (x40), Easy-Entry Blade; 18mm x 2.3mm (x40), Easy-Entry Fork; Ø3.7mm (4BA) (x10), Ø5.3mm (2BA) (x10), Easy-Entry Pin; 12mm x Ø1.9mm (x10), Easy-Entry Ring; Ø4.3mm (4BA) (x10), Ø6.4mm (1/4") (x10), Ø10.5mm (3/8") (x10), Female Socket; Ø5mm (x35), Fully Insulated Female; 4.8mm (x10), 6.3mm (x10), Piggy-Back; 6.3mm (x20), Push-On Female; 4.8mm (x10), 6.3mm (x10), Push-On Male; 6.3mm (x10)



066 AB041YT Kapalskór Sett
Gulir 140 stk



AB041YT
Bullet; Ø5mm (x10), Butt Connector; Ø5.5mm (x20), Easy-Entry Pin; 14 x Ø2.9mm (x10), Easy-Entry Ring; Ø5.3mm (2BA) (x10), Ø6.4mm (1/4") (x10), Ø8.4mm (5/16") (x10), Ø10.5mm (3/8") (x10), Ø13mm (1/2") (x10), Female Socket; Ø5mm (x10), Fully Insulated Female; 6.3mm (x10), Push-On Female; 6.3mm (x10), 9.5mm (x10), Push-On Male; 6.3mm (x10)



066 AK386 Kapalskór Sett
+ Krumptöng



Ýmsar stærðir



066 AK385 Töng fyrir raftengi



066 AK3863 Krumputöng stór



066 S0536 Kapalskór Sett
+ töng
Ýmsar stærðir
200stk



066 AK3858COMBO
Krumptöng með kjömmum



066 VS920 Raftengjasett



VS920
Red Handled - Spring Loaded Tube; 3.3 x 28mm, Square Blade; 1.4 x 28mm, Flat Blade; 1.5 x 24.75mm, 2 x 23mm, Fork Blade; 8 x 24mm, Screwdriver; 3/16" x 1". Green Handled - Tube; 3.3 x 28mm, 4.3 x 13mm, 3.75 x 13mm, 3 x 13mm, Flat Twin Blade; 3mm, 1.6mm



030 4471250 Rafmagnstöng 10"



066 VS9203 Verkfærasett
Til að losa raftengi



VS9203
BMW, Chrysler, Citroen, Fiat, Ford, Honda, Jaguar, Mazda, Mercedes, Mitsubishi, Porsche, Renault, Saab, Toyota, VAG, Vauxhall/Opel









066 SSCSET1 Tengjasett superseal
350stk









066 AK419 Afdráttarkló fyrir







RAFMAGNSVIR 1MM²
RAFMAGNSVIR 2MM²



	066 AC3220YE	Rafmagnsvír gulur	50m rúlla	1mm ²
	066 AC3220RE	Rafmagnsvír rauður	50m rúlla	1mm ²
	066 AC3220GR	Rafmagnsvír grænn	50m rúlla	1mm ²
	066 AC3220BU	Rafmagnsvír blár	50m rúlla	1mm ²
	066 AC3220BK	Rafmagnsvír svartur	50m rúlla	1mm ²
	066 AC3220WH	Rafmagnsvír hvítur	50m rúlla	1mm ²
	066 AC3220BN	Rafmagnsvír brúnn	50m rúlla	1mm ²



	066 AC2830YE	Rafmagnsvír gulur	50m rúlla	2mm ²
	066 AC2830RE	Rafmagnsvír rauður	50m rúlla	2mm ²
	066 AC2830GR	Rafmagnsvír grænn	50m rúlla	2mm ²
	066 AC2830BU	Rafmagnsvír blár	50m rúlla	2mm ²
	066 AC2830BK	Rafmagnsvír svartur	50m rúlla	2mm ²
	066 AC2830WH	Rafmagnsvír hvítur	50m rúlla	2mm ²
	066 AC2830BN	Rafmagnsvír brúnn	50m rúlla	2mm ²



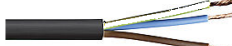



	482 304013-H	Kapall 2x1,5qm	Flatur	
		Tvíleiðari	Hv-sv	
		50m rúlla		

	482 304014-H	Kapall 2x1,5qm	Rúnaður	
		Tvíleiðari	Hv-sv	
		50m rúlla		



	482 304015-H	Kapall 3x1,5qm	Rúnaður	
		Þríleiðari	Hv-sv-blár	
		50m rúlla		

	482 304016-H	Kapall 4x1,5 qm	Rúnaður	
		Fjórleiðari	Hv-bl-br-rau	
		50m rúlla		



	482 304017-H	Kapall 5x1,5 qm	Rúnaður	
		Fimmleiðari		
		50m rúlla		

	482 304040	Gormasnúra 2 met.		
---	------------	-------------------	--	---



	482 304026	KAPALL 10qm SVARTUR		
---	------------	---------------------	--	--



	482 304005	Kerrukapall	7x0,75mm ²	
		Sjöleiðari.		
		50m rúlla		

	482 304029	KAPALL 25qm SVARTUR		
	482 304029-R	KAPALL 25qm RAUÐUR		

	482 304018-H	Kerrukapall	7x1,5mm ²	
		Sjöleiðari.		
		50m rúlla		

	482 304030	KAPALL 35qm SVARTUR		
	482 304031	KAPALL 35qm RAUÐUR		

	482 304045	Kerrukapall	4x2,5mm ² og 9x1,5mm ²	
		Prettán vírar		

	482 304032	KAPALL 50qm SVARTUR		
	482 304033	KAPALL 50qm RAUÐUR		

	030 4822401	Kapalhjól 18metrar	3 x 1,5mm ²	230V	
					

	065 DEL 32520	Kapalhjól 17metrar	3 x 2,5mm ²	230V	
--	---------------	--------------------	------------------------	------	---

HERPIHÓLKAR

HERPIHÓLKAR



066 HST100BR Herpíhólkur sett
Rauðir og svartir
95 stk
100mm



066 HST200MC Herpíhólkur sett
Ýmsir litir 100 stk
200mm



KAPALBÖND SVÖRT

KAPALBÖND HVÍT



047 FS100AWC Kapalbönd
2,5x100 Svart 100 stk

047 FS135AWC Kapalbönd
2,5x135 Svart 100 stk

047 FS160AWC Kapalbönd
2,5X160 Svart 100 stk

047 FS200AWC Kapalbönd
2,5X200 Svart 100 stk



047 FS200BWC Kapalbönd
3,5X200 Svart 100 stk

047 FS200CWC Kapalbönd
4,5X200 Svart 100 stk

047 FS280CWC Kapalbönd
4,5X280 Svart 100 stk



047 FS360CWC Kapalbönd
4,5X360 Svart 100 stk

047 FS200DWC Kapalbönd
7,5X200 Svart 100 stk

047 FS360DWC Kapalbönd
7,5x360 Svart 100 stk



047 FS135AC Kapalbönd
2,5x135 Hvítt 100 stk

047 FS140BC Kapalbönd
3,5x140 Hvítt 100 stk

047 FS200AC Kapalbönd
2,5X200 Hvítt 100 stk



047 FS200BC Kapalbönd
3,5x200 Hvítt 100 stk

047 FS200CC Kapalbönd
4,5X200 Hvítt 100 stk



047 FS360CC Kapalbönd
4,5x360 Hvítt 100 stk

047 FS200DC Kapalbönd
7,5X200 Hvítt 100 stk



066 CT375 Kapalbönd 375 stk
Model No: CT375
Sizes: 100 x 2.5, 150 x 3.6, 200 x 4.8mm
Colours: Black, Green, Red, Yellow, White



EINANGRUNABAND

EINANGRUNARBAND



530 19MMB
EINANGRUNARBAND SVART



530 19MMLB
EINANGRUNARBAND BLÁTT



530 19MMBR
EINANGRUNARBAND BRÚNT



530 19MMG
EINANGRUNARBAND GRÆNT



530 19MMGL
EINANGRUNARBAND GLÆRT



530 19MMGR
EINANGRUNARBAND GRÁTT



530 19MMGBR
EINANGRUNARBLAÐ GULBRÚNT



530 19MMLB
EINANGRUNARB. LÍÓS-BLÁTT



530 19MMLG
EINANGRUNARB. LÍÓS-GRÆNT



530 19MMO
EINANGRUNARBAND ORANGE



530 19MMR
EINANGRUNARBAND RAUTT



530 19MMW
EINANGRUNARBAND HVITT



530 19MMY
EINANGRUNARBAND GULT



530 19MMP
EINANGRUNARBLAÐ PURPLE

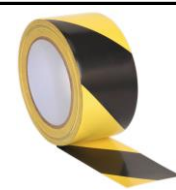

066 HWTBY Viðvörunarteip
50mmx33 metrar
Gult og svart















066 HWTRW Viðvörunarteip
50mmx33 metrar
Rautt og hvítt



PÓLSKÓR + PLÚS
PÓLSKÓR - MÍNUS

	482 507001-1	Pólskór plús			482 507002-1	Pólskór mínus	
	066 BTP1	Rafgeymaskór plús			066 BTP3	Rafgeymaskór plús	
	066 BTN2	Rafgeymaskór mínus			066 BTN4	Rafgeymaskór mínus	
	066 BTP21	Rafgeymaskór plús			066 BTP25	Rafgeymaskór plús	
	066 BTN22	Rafgeymaskór mínus			066 BTN26	Rafgeymaskór mínus	
	102 75-1010	Pólskór Universal Plús og mínus			066 AK417	Vírbusti fyrir Rafgeymaskó	
	Blisterpakking						

KAPALKLÆR
KAPALKLÆR

	482 507011	Krókóðila kjaftar 1 stk			482 507012-K	Kapalklær sett Rauð og svört	
	482 507040	Kapalklar "par" X-Hevy Duty					
	482 507036	Startkapalkló Rauð 400 Amp			482 507037	Startkapalkló Svört 400 Amp	
					102 75-2070	STARTKAPPLAR 16FT(21qx 4,8m)	

TÖNG FYRIR KAPALSKÓ
KAPALSKÓR

	482 305250	Töng fyrir kapalskó 9" H-Duty			066 LT108	Kapalskór 10mm ² 8mm gat
	066 AB016CT	Kapalskór stórir Sett 52 stk.			066 LT168	Kapalskór 16mm ² 8mm gat
		AB016CT Cable Diameter x Bolt Hole Size: 10mm ² x 8mm (x6), 16mm ² x 8mm (x6), 25mm ² x 6mm (x5), 25mm ² x 8mm (x5), 35mm ² x 8mm (x5), 35mm ² x 10mm (x5), 50mm ² x 8mm (x5), 50mm ² x 10mm (x5), 70mm ² x 10mm (x5), 70mm ² x 12mm (x5)			066 LT256	Kapalskór 25mm ² 6mm gat
	482 305325	Kapalskór 25mm ² Gat 10mm			066 LT258	Kapalskór 25mm ² 8mm gat
	066 AK422	Krumpuáhold fyrir kapalskó			066 LT358	Kapalskór 35mm ² 8mm gat
					066 LT3510	Kapalskór 35mm ² 10mm gat
					066 LT508	Kapalskór 50mm ² 8mm gat
					066 LT5010	Kapalskór 50mm ² 10mm gat
					066 LT7010	Kapalskór 70mm ² 10mm gat
					066 LT7012	Kapalskór 70mm ² 12mm gat

RAFMAGNSMÆLIR
066 MM20 Rafmagnsmælir AC/DC

Model No:	MM20
Specification:	
AC Voltage (Accuracy):	200V/600V (±2%)
DC Voltage (Accuracy):	200mV (±0.5%), 2V (±0.8%), 20V (±0.8%), 200V (±0.8%), 600V (±0.8%)
AC Current (Accuracy):	No
DC Current (Accuracy):	2mA (±1%), 20mA (±1%), 200mA (±1.2%), 10A (±2%)
Resistance (Accuracy):	200Ω, 2kΩ, 20kΩ, 200kΩ (±0.8%), 2MΩ (±1.2%)
Capacitance (Accuracy):	No
Temperature (Accuracy):	Range: -40°C-1000°C, (±1% up to 400°C), (±2% over 400°C)
Frequency (Accuracy):	No
Duty Cycle:	No
Continuity Audible:	Yes
Diode Test:	Yes
Transistor Test:	Yes
High-Impact Rubber Case:	Yes
Digits x Height:	6 x 12mm
Low Battery Indicator:	Yes
Batteries (Supplied):	1 x 9V
Information:	Integral Stand
Size (L x W x D):	140 x 70 x 35mm
Weight:	260g
Conformity:	IEC 1010

RAFMAGNSMÆLIR
066 TA200 AC/DC

Model No:	TA200
Specification:	
Tach (rpm):	4/6/8Cyl 0-10000 (x10)rpm
Diode:	4Cyl 0-90°, 8Cyl 0-90°, 8Cyl 0-45°
AC Voltage:	2V, 20V, 200V, 750V
DC Voltage:	200mV, 2V, 20V, 200V, 1000V
AC Current:	No
DC Current:	200mA, 10A
Capacitance:	No
Frequency:	No
Duty Cycle:	No
Pulse Width:	No
Resistance:	200Ω, 2kΩ, 20kΩ, 200kΩ, 2MΩ, 20MΩ
Continuity:	<30Ω
Temperature:	No
IR Temperature:	No
Diode Check:	Yes
Transistor Test:	No
Back Light:	No
Bar Graph Display:	No
Display Hold:	Yes
Auto-Ranging:	No
Inductive Coupler:	No
PC Interface:	No
Digits Height:	21mm
Auto Power Off:	No
Low Battery Indicator:	Yes
Batteries (Supplied):	9V (PP3)
H-Impact Case:	Yes
Size (L x W x D):	180 x 85 x 40mm
Weight:	353g

066 TA311 Ampertöng 40A/400A

28mm gat.

066 TA310 Ampertöng 20A/80A

12mm gat.

066 AK9999 Laser hallamál á þrífæti

066 TA112 Prófari fyrir rafrásir

TA112
LED Leads (x2), Back Probes (x4), Alligator Clips (x2), Standard Probes (x2), Connector/Cables (Piggy-Back) (x4), Spring Loaded Piercing Clip

066 TA111 Prófari fyrir rafrásir

TA111
Potentiometer; 5kΩ (x2), Alligator Clip (x2), Back Probe (x4), LED 2 Colour Strobes (x2), SRS Connector (x2), 1:2 Connector (x2), 1:1 Connector/Cables (Piggy-Back) (x4), Probe (x2), Round Terminals with Banana Socket; Male (x3)/Female (x3) - 1.5, 2, 3.5, 4mm, Flat Terminals with Banana Socket; Male (x3)/Female (x3) - 0.7, 0.8, 1.2, 2, 2.5, 3, 5, 6mm

066 TA125 Straummælir 80W



Model No:	TA125
Range:	0-80A - 0-48V
Accuracy:	± 2%
Fuse Type:	Mini, Standard, Maxi

066 TA130 Relay mælasett



Model No:	TA130
Dummy Relays:	7 Including 1 Universal Fly Lead
Terminal Configurations:	4, 5 Pin



482 507075 **Álagsmælir fyrir rafgeyma**

066 BT91/7 **Álagsmælir 6V-12V fyrir rafgeyma**

066 BT3000 **Rafgeymamælir Bluetooth**





Model No:	BT3000
Rated Battery Voltage:	6/12V
Charging System Capability:	12/24V
Rating Systems:	DIN, EN, IEC, SEA, CA/MCA
Test Range:	25-1300 CCA* DIN
	40-2100 CCA* EN
	30-1500 CCA* IEC
	40-2000 CCA* SEA
	50-2400 CA/MCA
*CCA - Cold Cranking Amps	
Voltage Range:	1.5-32V
Wireless Connection Range:	10mtr
Operating System:	(Apple) iOS 8.0 and later, Android OS 4.3 and later.
Note:	n/a



066 BT2014 **Rafgeyma og Alternator prufari**



Með prentara



066 VS2072 **Minniskubbur fyrir Minniskóða**



Model No:	VS2072	EOBD
Cable Length:	1.35mtr	
Connection:	EOBD	



066 BT105 **Mælitæki 12V**



Model No:	BT105
Rated Battery Voltage:	12V
Rating Systems:	CCA, BCI, CA, DIN, EN, GB, IEC, MCA, SAE
Test Ranges:	100-2000 CCA* CCA
	100-2000 CCA* BCI
	100-2000 CCA* CA
	100-1400 CCA* DIN
	100-2000 CCA* EN
	100-1400 CCA* GB
	100-1400 CCA* IEC
	100-2000 CCA* MCA
	100-2000 CCA* SAE
	By Battery Type JIS
Rated Battery Voltage:	12V
PC Compatibility:	Windows 7, 8, 10
Languages:	English, Danish, Norwegian, Polish, Romanian
*CCA - Cold Cranking Amps	

Fyrir rafgeyma og rafala



066 VS0564 **Dekkjamælir digital**



Model No:	VS0564
Range:	0-25mm(0-1")
Resolution:	0.01mm(0.0005")
Accuracy:	±0.02mm(0.001")
Battery:	LR44 - 1.5V (supplied)



066 TA050 **Snúningshraðamælir**



Model No:	TA050
Measures:	Range/Units:
Rotation Speed - Contact:	2-20,000rpm
Rotation Speed - Non-contact:	2-99,999rpm
Total Revolutions:	1-99,999
Sampling Time:	0.5s @ >120rpm
Accuracy:	± (0.05% + 1 digit)
Surface Speed:	mtr/min, in/min, ft/min, yd/min
Distance:	mtr, in, ft, yd
Frequency:	Hz
Battery:	PP3
External Power:	6V DC



066 TSTPG11 **Dekkjaloftmælir**



Model No:	TSTPG11
Scale:	0.21-10.3bar(3-150psi, 0.21-10.5kg/cm², 21-1034kPa)
Resolution:	0.5psi
Accuracy:	±1psi
Pressure Units:	bar, psi, kg/cm², kPa
Tread Depth Range:	0-20mm
Battery:	2 x CR2032 3V (supplied)
Connector Length:	n/a
Operating Temperature:	null



066 RCD981 **Yfirálagsvörn 230V**



Model No:	RCD981
Voltage:	230V
Maximum Load:	3kW
Maximum Operating Current:	13A
Trip Speed:	30ms
Trip Current:	30mA



066 RCD981 **Yfirálagsvörn 230V**



Model No:	RCD981
Voltage:	230V
Maximum Load:	3kW
Maximum Operating Current:	13A
Trip Speed:	30ms
Trip Current:	30mA





066 VS904 Hitamælibyssa 12:1

Model No:	VS904
Focal Ratio:	12:1
Temperature Range:	-50°C to +550°C (-58°F to +1022°F)
Accuracy:	-50°C to 0°C; ±3°C, 0°C to +550°C; ±1.5°C or ±1.5% whichever is greater



066 VS909 Vasahitamæli 9:1

Model No:	VS909
Focal Ratio:	9:1
Temperature Range:	-33°C to +500°C (-27°F to +932°F)
Accuracy:	±2.0%



066 VS027 Bremsuvökvamæli
Dot 3-4-5,1

Model No:	VS027
Moisture Content:	
Green:	<0.5%
Yellow:	0.5-3.5%
Red:	>3.5%



066 VS0271 Bremsuvökvamæli
Dot 3-4-5,1

Just 3% of moisture can lower the brake fluid boiling point by over 100°C. The best way to detect this small water content is to measure the boiling point of the fluid. The unit incorporates a heater element, LCD display and a power lead for use on 12V DC power supplies.



066 VS0274 Bremsuvökvamæli

- Integrated circuitry checks moisture content of fluid by measuring the electrical resistance and comparing it with acceptable limits.
- Easy calibration check using water.
- Five LED read-out.
- Just switch on and insert probe for immediate result.

AAA - Rafhlaða.



066 TA091 Lakkþykktarmæli

Svið 0-2mm

CR2032 Rafhlaða



066 AK414 Sýrumæli
fyrir rafgeyma



066 AK410 Sýrumæli
fyrir rafgeyma
6V, 12V, 24 V



S4 LÍNAN FRÁ BOSCH

 <p>S4000 Rafgeymir 44Ah Hægri + 12V 420A L=175 B=175 H=190  BOSCH</p>	 <p>S4001 Rafgeymir 44Ah Hægri + 12V 440A L=207 B=175 H=175  BOSCH</p>
 <p>S4002 Rafgeymir 52Ah Hægri + 12V 470A L=207 B=175 H=190  BOSCH</p>	 <p>S4004 Rafgeymir 60Ah Hægri + 12V 540A L=242 B=175 H=175  BOSCH</p>
 <p>S4005 Rafgeymir 60Ah Hægri + 12V 540A L=242 B=175 H=190  BOSCH</p>	 <p>S4006 Rafgeymir 60Ah Vinstri + 12V 540A L=242 B=175 H=190  BOSCH</p>
 <p>S4007 Rafgeymir 72Ah Hægri + 12V 680A L=278 B=175 H=175  BOSCH</p>	 <p>S4008 Rafgeymir 74Ah Hægri + 12V 680A L=278 B=175 H=190  BOSCH</p>
 <p>S4009 Rafgeymir 74Ah Vinstri + 12V 680A L=278 B=175 H=190  BOSCH</p>	 <p>S4010 Rafgeymir 80Ah Hægri + 12V 740Ah L=315 B=175 H=175  BOSCH</p>
 <p>S4018 Rafgeymir 40Ah Hægri + 12V 330A L=187 B=127 H=227  BOSCH</p>	 <p>S4019 Rafgeymir 40Ah Vinstri + 12V 330Ah L=187 B=127 H=227  BOSCH</p>
 <p>S4020 Rafgeymir 45Ah Hægri + 12V 330A L=238 B=129 H=227  BOSCH</p>	 <p>S4021 Rafgeymir 45Ah Hægri + 12V 330A L=238 B=129 H=227  BOSCH</p>
 <p>S4022 Rafgeymir 45Ah Vinstri + 12V 330A L=238 B=129 H=227  BOSCH</p>	 <p>S4023 Rafgeymir 45Ah Vinstri + 12V 330A L=238 B=129 H=227  BOSCH</p>
 <p>S4024 Rafgeymir 60Ah Hægri + 12V 540A L=232 B=173 H=225  BOSCH</p>	 <p>S4025 Rafgeymir 60Ah Vinstri + 12V 540A L=232 B=173 H=225  BOSCH</p>
 <p>S4026 Rafgeymir 70Ah Hægri + 12V 630A L=260 B=175 H=220  BOSCH</p>	 <p>S4027 Rafgeymir 70Ah Vinstri + 12V 630A L=260 B=175 H=220  BOSCH</p>
 <p>S4028 Rafgeymir 95Ah Hægri + 12V 830A L=306 B=173 H=225  BOSCH</p>	 <p>S4029 Rafgeymir 95Ah Vinstri + 12V 830A L=306 B=173 H=225  BOSCH</p>
 <p>S4030 Rafgeymir 40Ah Hægri + 12V 330A L=187 B=140 H=227  BOSCH</p>	

RAFGEYMAR
Start/Stop rafgeymar

	S4E05 Hægri + 12V L=242 B=175 H=190	Rafgeymir 60Ah 560A EFB 16,67kg BOSCH
	S4E08 Hægri + 12V L=278 B=175 H=190	Rafgeymir 70Ah 650A EFB 19,14kg BOSCH
	S4E40 Hægri + 12V L=232 B=173 H=225	Rafgeymir 65Ah 650A EFB 16,93kg BOSCH
	S4E42 Hægri + 12V L=303 B=173 H=225	Rafgeymir 85Ah 800A EFB 21,69kg BOSCH





RAFGEYMAR
Start/Stop rafgeymar

	S4E07 Hægri + 12V L=278 B=175 H=175	Rafgeymir 65Ah 650A EFB 18,63kg BOSCH
	S4E10 Hægri + 12V L=315 B=175 H=175	Rafgeymir 75Ah 730A EFB 21,19kg BOSCH
	S4E41 Hægri + 12V L=261 B=175 H=220	Rafgeymir 72Ah 760A EFB 19,55kg BOSCH
	EK151 Vinstri + 12V L=150 B=90 H=145	Rafgeymir 15Ah 200A 4,8kg EXIDE



SILVER
S5 LÍNAN FRÁ BOSCH
SILVER

	S5005 Hægri + 12V L=242 B=175 H=190	Rafgeymir 63Ah 610A 14,85kg BOSCH
	S5013 Hægri + 12V L=353 B=175 H=190	Rafgeymir 100Ah 830A 21,71kg BOSCH
	S5011 Hægri + 12V L=315 B=175 H=190	Rafgeymir 85Ah 800A 19,36kg BOSCH
	S5015 Hægri + 12V L=393 B=175 H=190	Rafgeymir 110Ah 920A 25,0kg BOSCH



Start/Stop rafgeymar
S5 LÍNAN FRÁ BOSCH
Start/Stop rafgeymar

	S5A05 Hægri + 12V L=242 B=175 H=190	Rafgeymir 60Ah 680A 17,35kg BOSCH
	S5A11 Hægri + 12V L=315 B=175 H=190	Rafgeymir 80Ah 800A 22,76kg BOSCH
	S5A15 Hægri + 12V L=394 B=175 H=190	Rafgeymir 105Ah 950A 29,4kg BOSCH
	S5A08 Hægri + 12V L=278 B=175 H=190	Rafgeymir 70Ah 760A 20,09kg BOSCH
	S5A13 Hægri + 12V L=353 B=175 H=190	Rafgeymir 95Ah 850A 25,92kg BOSCH







Neyslugeymar fyrir bíla og hjólhýsi

	L4027 Vinstri + 12V L=272 B=175 H=225	Rafgeymir 75Ah 18,1kg BOSCH
	L5013 Hægri + 12V L=353 B=175 H=190	Rafgeymir 90Ah 800A 23,73kg BOSCH





Neyslugeymar fyrir bíla og hjólhýsi

	L4034 Vinstri + 12V L=330 B=172 H=238	Rafgeymir 105Ah 800A 23,7kg BOSCH
	L5075 Vinstri + og - 12V L=513 B=189 H=223	Rafgeymir 140Ah 800A 35,76kg BOSCH







RAFGEYMAR
Neyslugeymar fyrir bíla og hjólhýsi







	L5077 Vinstri + og - L=513 B=223 H=223	Rafgeymir 180Ah 12V 1000A 45,1kg	
	6FM45 Hægri + L=197 B=165 H=170	Rafgeymir 45Ah 12V 14,6kg	
	6FM100D-X L:330 B=171 H=220	Rafgeymir 100Ah 12V 32kg	

RAFGEYMAR
Neyslugeymar fyrir bíla og hjólhýsi



	L5080 Vinstri + og - L=518 B=276 H=242	Rafgeymir 230Ah 12V 1150A 56,75kg	
	6FM75 Vinstri + L=258 B=168 H=211	Rafgeymir 75Ah 12V 700A 21,2kg	

Rafgeymar fyrir traktora og vinnuvélar
T3 LÍNAN FRÁ BOSCH
Rafgeymar fyrir traktora og vinnuvélar





	T3036 Vinstri + L=346 B=173 H=236	Rafgeymir 110Ah 12V 680A 28,58kg	
	T3040 Hægri + L=344 B=175 H=285	Rafgeymir 125Ah 12V 720A 31,22kg	
	T3045 Vinstri + og - L=514 B=175 H=210	Rafgeymir 135Ah 12V 1000A 35,46kg	



	T3037 Hægri + L=346 B=173 H=236	Rafgeymir 110Ah 12V 680A 28,58kg	
	T3041 Vinstri + L=344 B=175 H=285	Rafgeymir 125Ah 12V 720A 31,22kg	
	T3047 Vinstri + og - L=514 B=218 H=210	Rafgeymir 143Ah 12V 950A 39,85kg	

Rafgeymar fyrir traktora og vinnuvélar
T4 LÍNAN FRÁ BOSCH
Rafgeymar fyrir traktora og vinnuvélar





	T4075 Vinstri + og - L=513 B=189 H=223	Rafgeymir 140Ah 12V 800A 35,76kg	
---	--	--	---





Rafgeymar fyrir traktora og vinnuvélar
T5 LÍNAN FRÁ BOSCH
Rafgeymar fyrir traktora og vinnuvélar

	T5077 Vinstri + og - L=513 B=223 H=223	Rafgeymir 180Ah 12V 1000A 44,14kg	
	643107. Hægri + L=508 B=174 H=205	Rafgeymir 143Ah 12V 900A 37kg	



	T5080 Vinstri + og - L=518 B=276 H=242	Rafgeymir 225Ah 12V 1150A 57,5kg	
---	--	--	---

Rafgeymar fyrir USA bíla
Rafgeymar fyrir USA bíla

	515 L=168 B=132 H=176	Rafgeymir 30Ah 12V 350A 8,5kg	
	790 L=257 B=175 H=180	Rafgeymir 65Ah 12V 790A 18,5kg	

	670 L=235 B=175 H=180	Rafgeymir 60Ah USA 12V 640A 14,5kg	
	850 L=292 B=189 H=191	Rafgeymir 90Ah 12V 900A 20kg	

RAFGEYMAR
Ýmsar gerðir 6V
RAFGEYMAR
Ýmsar gerðir 6V

	<p>T105-TROJAN Rafgeymir 225Ah 6V L=264 B=181 H=272 29kg </p>	
--	---	--

Rafgeymar 12V
Varta Promotive Black
Rafgeymar 12V

	<p>I18 Rafgeymir 110Ah Hægri + 12V 680A L=347 B=173 H=234 29,9kg </p>		<p>J1 Rafgeymir 125Ah Hægri + 12V 720A L=349 B=175 H=290 31,22kg </p>
	<p>K8 Rafgeymir 140Ah Vinstri + 12V 800A L:513 B=189 H=223 35,76kg </p>		

Rafgeymar fyrir mótorhjól, fjórhjól og fl.
Rafgeymar fyrir mótorhjól, fjórhjól og fl.

	<p>LTX5LBS Rafgeymir 20Wh Hægri + 12V 95A L=113 B=70 H=85 0,4kg M Li-ion </p>		<p>LTX7ABS Rafgeymir 2,4Ah Hægri + 12V 150A L=150 B=87 H=93 0,6kg M Li-ion </p>
--	--	---	--

Rafgeymar fyrir mótorhjól, fjórhjól og fl.
Rafgeymar fyrir mótorhjól, fjórhjól og fl.
Varta Powersports AGM













	<p>503014. Rafgeymir 3Ah Hægri + 12V 40A L=114 B=71 H=86 </p>		<p>504012. Rafgeymir 4Ah Hægri + 12V 80A L=114 B=71 H=106 </p>
	<p>507902. Rafgeymir 5Ah Hægri + 12V 120A L=113 B=70 H=105 </p>		<p>506014. Rafgeymir 6Ah Hægri + 12V 100A L=114 B=71 H=131 </p>
	<p>506015. Rafgeymir 6Ah Vinstri + 12V 105A L=151 B=88 H=94 </p>		<p>507901. Rafgeymir 7Ah Vinstri + 12V 120A L=150 B=66 H=94 </p>
	<p>508901. Rafgeymir 8Ah Vinstri + 12V 150A L=150 B=87 H=93 </p>		<p>509902. Rafgeymir 8Ah Vinstri + 12V 115A L=149 B=70 H=105 </p>
	<p>508012. Rafgeymir 8Ah Vinstri + 12V 135A L=152 B=88 H=106 </p>		<p>509901. Rafgeymir 9Ah Vinstri + 12V 200A L=150 B=87 H=110 </p>
	<p>510012. Rafgeymir 10Ah Vinstri + 12V 150A L=152 B=88 H=131 </p>		<p>511902. Rafgeymir 11Ah Vinstri + 12V 230A L=150 B=87 H=110 </p>
	<p>512901. Rafgeymir 12Ah Vinstri + 12V 215A L=151 B=70 H=131 </p>		<p>512014. Rafgeymir 12Ah Vinstri + 12V 200A L=152 B=88 H=147 </p>

RAFGEYMAR
RAFGEYMAR
Varta Powersports AGM

	<p>513903. Rafgeymir 13Ah Vinstri + 12V 190A L=152 B=70 H=150</p> 		<p>518918. Rafgeymir 18Ah Hægri + 12V 320A L=175 B=87 H=154</p> 
	<p>518901. Rafgeymir 18Ah Hægri + 12V 250A L=177 B=88 H=156</p> 		<p>518902. Rafgeymir 18Ah Vinstri + 12V 250A L=177 B=88 H=156</p> 
	<p>518908. Rafgeymir 18Ah Vinstri + 12V 270A L=150 B=87 H=161</p> 		<p>521908. Rafgeymir 21Ah Hægri + 12V 340A L=205 B=87 H=164</p> 

	<p>519901. Rafgeymir 19Ah 12V 170A L=186 B=82 H=173 GEL Polir 90° halla.</p> 	
---	---	--

Varta Powersports Freshpack













	<p>512011. Rafgeymir 12Ah Vinstri + 12V 160A L=136 B=82 H=161</p> 		<p>512013. Rafgeymir 12Ah Hægri + 12V 160A L=136 B=82 H=161</p> 
	<p>514011. Rafgeymir 14Ah Hægri + 12V 190A L=135 B=90 H=167</p> 		<p>514012. Rafgeymir 14Ah Vinstri + 12V 190A L=136 B=91 H=168</p> 
	<p>530400. Rafgeymir 30Ah Hægri + 12V 300A L=168 B=132 H=176</p> 		
	<p>513106. Rafgeymir 13Ah Hægri + 12V 200A L=150 B=87 H=146 Silver Aux AGM</p> 		

--	--	--

--	--	--

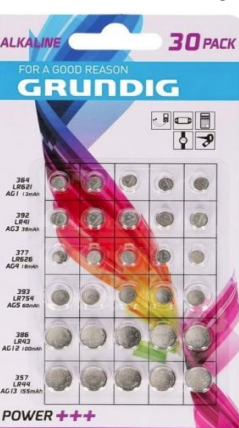
			<p>066 BT91/7 Rafgeymaburðarkló</p> 
--	--	---	---

RAFHLÖÐUR
RAFHLÖÐUR

 	<p>860 LR1 Rafhlaða 1,5V fyrir fjarstýringar.</p> <p>4001. LADY ALKALINE 1 stk í pakka</p>		<p>860 LR3 Rafhlaða 1,5V AAA Stærð</p> <p>ALKALINE LONGLIFE 4 stk í pakka</p>																		
	<p>860 LR6 Rafhlaða 1,5V AA Stærð</p> <p>ALKALINE LONGLIFE 4 stk í pakka</p>		<p>860 LR14 Rafhlaða 1,5V C Stærð</p> <p>ALKALINE LONGLIFE 2 stk í pakka</p>																		
	<p>860 LR20 Rafhlaða 1,5V D Stærð</p> <p>ALKALINE LONGLIFE 4 stk í pakka</p>		<p>860 6LR61 RAFHLAÐA 9V E Stærð</p> <p>ALKALINE LONGLIFE 1 stk í pakka</p>																		
	<p>660 DSMN21B2 Rafhlaða 12V MN21 A23</p> <p>Fyrir þráðlausar fjarstýringar. Dyrabjöllur og öryggiskerfi</p> <p>ALKALINE 2 stk í pakka</p> <p>Long lasting power.</p>		<p>440 871125204032 Rafhlaða LR43 / AG12 Stærð</p> <p>ALKALINE GRUNDIG 6 stk í pakka</p>																		
	<p>440 871125285574 Rafhlöður 30stk</p> <table border="0"> <tr><td>LR621</td><td>13mAh</td><td>5stk</td></tr> <tr><td>LR41</td><td>38mAh</td><td>5stk</td></tr> <tr><td>LR626</td><td>18mAh</td><td>5stk</td></tr> <tr><td>LR754</td><td>60mAh</td><td>5stk</td></tr> <tr><td>LR43</td><td>100mAh</td><td>5stk</td></tr> <tr><td>LR44</td><td>155mAh</td><td>5stk</td></tr> </table> <p>POWER +++ ALKALINE - GRUNDIG</p>	LR621	13mAh	5stk	LR41	38mAh	5stk	LR626	18mAh	5stk	LR754	60mAh	5stk	LR43	100mAh	5stk	LR44	155mAh	5stk		<p>440 8711252538921 Rafhlaða CR1620 70mAh</p> <p>LITHIUM GRUNDIG 5 stk í pakka</p> <p>860 CR1620 = 1stk</p>
LR621	13mAh	5stk																			
LR41	38mAh	5stk																			
LR626	18mAh	5stk																			
LR754	60mAh	5stk																			
LR43	100mAh	5stk																			
LR44	155mAh	5stk																			
			<p>860 CR2025 Rafhlaða CR2025</p> <p>LITHIUM 1 stk í pakka</p>																		
	<p>860 CR2032 Rafhlaða 3V CR2032 200mAh</p> <p>LITHIUM 1 stk í pakka</p>		<p>440 871125214143 Rafhlaða 3V CR2032 200mAh</p> <p>LITHIUM 5 stk í pakka</p>																		











GLITMERKI GUL
GLITMERKI RAUÐ

	482 202005-B Glitauga gult 60mm 5mm bolti		482 202003 Glitmerki rautt 100x45mm
	482 202001 Glitmerki rautt þríhyrningur 160mm		066 TB17 Glitmerki rautt 2stk 160x140mm
	066 TB25 Glitmerki gult 2stk 75x46x10mm		066 TB24 Glitmerki rautt 2stk 75x46x10mm
	297 810655 Glitauga gult 60mm		482 202004 Glitmerki gult 100x45mm





























GLITMERKI HVÍTT

	482 202008-B Glitauga Hvítt 60mm 5mm bolti		298 EW0200 Inniljós Led 12-24V 0,4A Lumens 425 140mm
	066 TB23 Glitauga Hvítt 2stk 75x46x10mm		298 EW0601 Inniljós Led 12-24V 144 Led 2,0 A Lumens 3700 635x100



INNILJÓS

	297 800338-12 Inniljós Led 12V Með hreyfiskynjara 1mín 238x20,6x10,4mm		298 EW9001 Inniljós Led 12/24V 3x0,4W 0,08A Ljós í kverk EMC 130x25x25mm
	298 EW9002 Inniljós Led 12/24V 6x0,4W 0,17A Ljós í kverk EMC 230x25x25mm		298 EW9003 Inniljós Led 12/24V 12x0,4W 0,28A Ljós í kverk EMC 431x25x25mm
	298 EW9000 Inniljós Led 12/24V 12x0,4W 0,28A EMC 386x69mm		298 EW9004 Inniljós Led 12/24V EMC 401x78mm
	298 EW9005 Inniljós Led 12/24V 30x0,4W 0,56A EMC 401x (90mm)		298 EW0600 Inniljós Led 12/24V 96 Led 1,1A Lumens 2000 460x100 (18")
	066 GL93 Ledljós með hreyfiskynjara 1W 3x AA rafhlöður		066 GL931 Ledljós með hreyfiskynjara 1,2W 3x AA rafhlöður

AFTURLJÓŚ LED
AFTURLJÓŚ

 <p>482 203001-LED Afturljós 12V 115x115mm</p> 	 <p>482 203013-LED Afturljós 10-30V 140x85mm</p> 
 <p>066 TB18 Afturljós 12V 98x98mm</p> <p>Perurnar fylgja.</p> 	 <p>482 203002-LED Afturljós 105x98mm 12V-24V "Multi-volt" Með númera ljósi.</p> 
 <p>482 203065-LED Afturljós 150x80x26mm</p> 	 <p>482 203065-W-LED Afturljós 150x80x26mm 10-30V Hvítt gler</p> 
 <p>297 800398V Afturljós Led 233x143x55mm 12-24V Vinstri Kapall 1,95m IP68</p> 	 <p>297 800398H Afturljós Led 233x143x55mm 12-24V Hægri Kapall 1,95m IP68</p> 
 <p>297 CLC-888L Afturljós Led 397x128x46mm 24V 70 Led ljós. 152mm á milli gata.</p> 	 <p>297 800344 Ljós aftan 12 Led 9-36V Rautt 230mm snúra 84x24x10mm</p> 
 <p>297 800050 Afturljós 12/24V Led 100x120x55mm</p> 	 <p>297 800341 Ljós aftan 3 Led 9-36V Rautt 230mm snúra 84x24x10mm</p> 
 <p>297 800268 Bakkljós Led 12-24V 107x47x25mm IP66/68 38cm snúra.</p> 	 <p>297 800269 Þokuljós Led 12-24V 107x47x23mm IP66/68 38cm snúra.</p> 

 <p>297 800188 Staðsetningarljós Hvítt 12V/24V 20cm snúra 76x57,5x42mm</p> 	 <p>297 800188-R Staðsetningarljós Rautt 12V/24V 20cm snúra 76x57,5x42mm</p> 
 <p>297 800190 Staðsetningarljós Hvítt báðum megin 12V/24V 35cm snúra 99,5x52x44,5mm</p> 	 <p>297 800345 Ljós 12 Led 9-36V Hvítt 230mm snúra 84x24x10mm</p> 



 <p>482 206010-LED Númeraljós 12V LED 12V</p>  <p>80x35x35mm</p>	
 <p>066 TB12 Númeraljós 12V Svart</p>  <p>110x39x45mm</p>	 <p>297 800031 Númeraljós 12-24V LED Rautt</p>  <p>109x61x55,5</p>
 <p>297 800031-S Númeraljós 12-24V LED Svart</p>  <p>109x61x55,5</p>	 <p>297 800032-S Númeraljós 12-24V LED Svart</p>  <p>82,5x39x31</p>

HLIÐARLJÓS
HLIÐARLJÓS



 <p>482 203020 Hliðarljós á stétt 12V Glært/rautt</p> 	 <p>482 203020-LED Hliðarljós á stétt 12/24V Hvítt/rautt</p> 
 <p>297 800370-N Hliðarljós gúmmí 12-24V Hvítt/rautt</p> 	 <p>482 203022-LED Hliðarljós gúmmí 12-24V Hvítt/rautt</p> 
 <p>482 203021-LED Hliðarljós gúmmí 12-24V Hvítt/rautt</p> 	 <p>482 203021 Hliðarljós L=16cm Hvítt/rautt</p> 
 <p>297 800371V-N Hliðarljós gúmmí Vinstri 12-24V Hvítt/rautt</p> 	 <p>297 800371H-N Hliðarljós gúmmí Hægri 12-24V Hvítt/rautt</p> 
 <p>297 800372V-N Hliðarljós gúmmí Vinstri 12-24V Hvítt/rautt</p> 	 <p>297 800372H-N Hliðarljós gúmmí Hægri 12-24V Hvítt/rautt</p> 
 <p>482 203045-LED Led ljós gult 24V</p> <p>110x45mm</p> 	 <p>482 203045-LED-M Led ljós gult 10-30V</p> <p>110x45mm</p> 
 <p>297 800340 Hliðarljós 3 Led 9-36V Gult</p> <p>230mm snúra 84x24x10mm</p> 	 <p>297 800343 Hliðarljós 12 Led 9-36V Gult</p> <p>230mm snúra 84x24x10mm</p> 

LJÓSKASTARAR
LJÓSKASTARAR



297 270771 Ljóskastari 9"
Halogen H7 perur
55W/70W IP56 12V/24V
223,7x243,57x122mm



297 270918 Ljóskastari Hestra
7" Led
45W IP67 9-32V
177.8x201x70.5mm



297 270511 Ljóskastari ökuljós
7" Cree Led
60W IP67 10-40V
177,8x222x79mm



297 270512 Ljóskastari ökuljós
9" Cree Led
60W IP67 10-40V
228x275x93mm



297 270914 Ljóskastari Sala
7" Cree Led
40W IP67 10-30V
182,4x188.4x85mm



297 270913 Ljóskastari Sveg
9" Cree Led
60W IP67 10-30V
232x239x79mm



297 270905 Ljóskastari Fritsla
9" Cree Led
50W IP68 9-33V
225x250x130mm

297 270906 Ljóskastari Extraljós
9" Led 32stk
96W IP68 9-36V
221x232x111mm

297 270773 Ljóskastari Visby
9" Xenon perur
35W IP56 9-36V
224x248.4x134.2mm





297 270900-12 Ljóskastari Lycksele
9" Xenon perur
D1S 35W/85V 12V/24V
228x224x122mm





298 EW3010 Ljóskastari 360°
Með fjarstýringu 12-24V
2.7A
LUMENS 2250
HALLASVIÐ 135°









297 270919 Ljóskastari Boda
9" Led
75W IP67 9-36V
223x288,6x73mm



297 809077 Ljóskastari Floby
8" Led
120W IP68 9-36V
208x230x96mm

VINNULJÓS MEÐ PERUM
VINNULJÓS MEÐ PERUM



298 PW1010SP Vinnuljós H3 pera
12/24V
55W/12V 70W/24V
106x106x84mm



298 PW1014SP Vinnuljós H3 pera
12/24V
55W/12V 70W/24V
140x100x92mm

LJÓSBAR LED
LJÓSBAR LED



297 809105 Ljósabar Led 72W
Lumen 6480/3269
72W IP67 12-24V
358x78,5x86,5mm

297 809202 Ljósabar Led 70W
Lumen 5567
70W IP68 12-34V
551x72,3x53,5mm



















066 LED038 Vinnuljós Led 36
230V Lumen 420
1230/1940mm
Undir húdd, samanbrjótanlegt

066 LED136 Vinnuljós
230V Lumen 1400
1230/1680mm
Undir húdd, samanbrjótanlegt



VINNULJÓS
VINNULJÓS

	297 809000 Vinnuljós Led mini Lumen 468 12W IP67 9-30V 72x65x40,5mm strands -lighting division		297 809002 Vinnuljós Led mini Lumen 1000/960 5x3W IP67 10-30V 85x85x40mm strands -lighting division
	297 809240 Vinnuljós Led 92W Led Osram Lumen 15000 IP69K 10-32V 110x110x57mm strands -lighting division		297 809517 Vinnuljós Led 25W Lumen 3040/2200 16X1,5W IP69K 9-32V 108x139x48mm strands -lighting division
	297 809523 Vinnuljós Led 15W Lumen 1710/1250 IP67/69K 9-32V 107x41,5mmx133mm strands -lighting division		
	297 809071 Vinnuljós Led 27W CREE LED Lumen 2430/1700 27W IP68 9-32V 109x117,5x75mm strands -lighting division		297 908517 Vinnuljós Led 25W Lumen 3040 25W IP67 110x110x47mm strands -lighting division
	297 809017 Vinnuljós Led 48W Lumen 3360/2088 48W IP67 10-30V 115x115x72mm strands -lighting division		066 WL48W Vinnuljós Led 48W Lumen 3450 48W IP67 9-32V 125x100 SEALEY
	297 809070 Vinnuljós Led 60W CREE LED Lumen 5400/3900 60W IP68 9-50V 155x130x66mm strands -lighting division		297 808011 Vinnuljós Led 64W Led Osram Lumen 6187/5200 64W IP67/69K 9-32V 101x101x45mm strands -lighting division
	297 809030 Vinnuljós Led 15W Lumileds Lumen 1960/1862 15W IP68/69K 9-30V 144x49.6x74.5mm strands -lighting division		297 809063 Vinnuljós Lyftara Blátt ljós í kringum lyftarann. 12-24V 140x90x87mm strands -lighting division
	297 TD90007 Vinnuljós m/segli 18W IP67 12-24V 165x72x75mm strands -lighting division		066 LED121 Vinnuljós Led 15W Lumen 900 M/segli 1,5metra snúra. 12V SEALEY
	297 809026 Vinnuljós Led 18W Lumen 1260/1080 18W IP67 10-30V 160x70x56mm strands -lighting division		066 LED3RM Vinnuljós Led Lumen 2160 M/Segli 10-30V SEALEY
	298 EW3114 Vinnuljós Led 60W Lumen 2600 IP67 12-24V 14" á lengd VISION ALERT		298 EW3214 Vinnuljós Led 120W Lumen 4800 IP67 12-24V 14" á lengd VISION ALERT



















VINNULJÓS HLAÐANLEGT
VINNULJÓS Á FÆTI

	297 TD90006 Vinnuljós Led 15W Hleðsluljós Lumen 960 Full hleðsla á 4 klukkust. 277x84x37mm strands -lighting division		030 4821106 Vinnuljós Led 30W Lumen 3300 230V 270x270mm SONIC equipment
	066 LED200WS Vinnuljós Led Með hleðslubanka Með hátalara Fimm stillingar Lumen frá 100-2000 SEALEY		066 LED360FR Vinnuljós á fæti rautt Lumen 3000 Hleðsluljós Lithium SEALEY

















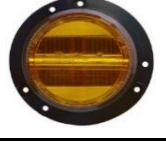





























ÞOKULJÓS

ÞOKULJÓS

 297 270708 Pokuljós 30W Alaska Lumen 1008/1380 IP67 9-32V 200x142x85mm 	 297 270775 Pokuljós 80W Delta Lumen 6200 IP67 12-48V 245x140x90mm 
 297 270785 Pokuljós 60W Sigma Lumen 4590 IP67 12-24V 180x65mm 	 297 270777 Pokuljós 7" 66W Lumen 4469 IP68 12-24V 178x88mm 
 297 270787 Pokuljós 9" 120W Lumen 10200 IP68 9-36V 218x84mm 	 297 270926 Pokuljós 9" 50W Lumen 3500 IP68 9-33V 223x119.5mm 

 066 LED086 Fljóðljós m/skynjara 10W IP54 230V Lumen 800 Dreifir ljósi 110° 	 066 LED087 Fljóðljós m/skynjara 20W IP54 230V Lumen 1600 Dreifir ljósi 110° 
 066 LED089 Fljóðljós m/skynjara 70W IP54 230V Lumen 5600 	 066 LED080 Fljóðljós 10W IP54 230V Lumen 800 Dreifir ljósi 110° 
 066 LED113 Fljóðljós extra slim 50W IP65 230V Lumen 4500 	 066 LED114 Fljóðljós extra slim 70W IP65 230V Lumen 5600 
<p>066 LED24230 Vinnuljós Led 24W 24W IP65 230V Lumen 2500</p>  	
<p>066 LED184 Fljóðljós Led 20W Þrjár stillingar Lumen 1900/1100/650 Hleðslutími 9 klukkutímar.</p>  	<p>066 LED190T Fljóðljós Led 20W Þrjár stillingar IP65 Lumen 1600/800/480 Hleðslutími 5,5 klukkutímar.</p> <p>066 LED193ST Standur f/kastara</p>   

AÐVÖRUNARLIJÓS
AÐVÖRUNARLIJÓS

	298 3000260 Aðvörunarljós Led 12-48V Gult		298 30115270 Aðvörunarljós Xenon 10-100V Gult
	298 3000360 Aðvörunarljós Led 12-48V Rautt		298 30115370 Aðvörunarljós Xenon 10-100V Rautt
	298 3000460 Aðvörunarljós Led 12-48V Blátt		298 30115470 Aðvörunarljós Xenon 10-100V Blátt
	298 3000560 Aðvörunarljós Led 12-48V Grænt IP67 EMC		IP67 EMC
0,1A 81x54mm 		0,5A 81x54mm 	
	298 42600201 Aðvörunarljós Xenon 12-24V Gult IP65 EMC		298 43900204 Aðvörunarljós Xenon 12-24V Gult IP67 EMC
148x63mm 		77x45mm 	
	298 6260A Aðvörunarljós Led Mini 12-80V Gult Led Beacon		298 49800101 Aðvörunarljós Led ECE IP65 12-100V 3 Boltar Orion-Beacon
71x125mm 		147x106mm 	
	298 46809202 Aðvörunarljós Xenon 10-30V Gult		298 EB5010R Aðvörunarljós Led R10, IP65 12/24V 3 Boltar ECCOLEED
12mm bolti 112x147mm 		147x106mm 	
	298 EB5010G Aðvörunarljós Led R10, IP65 12-24V 3 Boltar ECCOLEED		298 EB5010A Aðvörunarljós Led R10, IP65 12/24V 3 Boltar ECCOLEED
148x120mm 		148x120mm 	
	298 EB5010B Aðvörunarljós Led R10, IP65 12/24V 3 Boltar ECCOLEED		298 EB5014A Aðvörunarljós Led R65, R10, II Gult 12/24V 3 Boltar ECCOLEED
148x120mm 		148x120mm 	
	297 800264 Aðvörunarljós Led IP66/IP68 Með segli 10-32V 3metra snúra Beacon		298 47001701 Aðvörunarljós Delta star m/segli
162x112mm 			
	297 809057 Aðvörunarljós Led ECE R65 Á rör 12-24V Rör gat 24mm Með rafmagnstengi		297 809056 Aðvörunarljós Led ECE R65 12-24V Beacon
128x235,5mm 		142x183mm 	
	298 404001 Aðvörunarljós flexi H1 pera 12V EMC 55W/70W		298 404002 Aðvörunarljós flexi H1 pera 24V EMC 55W/70W
134x214mm 		134x214mm 	
	298 304000 Aðvörunarljós Flexi EMC R65 H1 pera 12-24V 55W/70W		297 809058 Aðvörunarljós Led ECE R65 m/segli 12V-24V IP56
130x204mm 		141x181mm 	
	298 ED0016A Aðvörunarljós Gult m/segli		298 ED0016R Aðvörunarljós Rautt m/segli
Fyrir rafhlöður 4 x AA 		Fyrir rafhlöður 4 x AA 	

AÐVÖRUNARLIÓS
AÐVÖRUNARLIÓS

	298 49704201 Aðvörunarljós Led Gult 12-24V ECE R65 125x92x62mm 		298 49704401 Aðvörunarljós Led Blátt 12-24V ECE R65 125x92x62mm 
---	--	---	---

	298 48302202 Aðvörunarljós BAR Tvö ljós. Gult 12-24V IP54 370x185x175 		298 13-00001-E Aðvörunarljós Led Gult 12-24V 770x200x85 
---	---	--	--

	297 8508949 Aðvörunarljós Led ECE R65 480mm 12-24V 		297 8508950 Aðvörunarljós Led ECE R65 900mm 12-24V 
---	--	---	--

	066 MLB80MB Ljósabari mini IP56 12-24V 80 Led Með segli 279x165x61mm 		066 MLB80SB Ljósabari mini IP56 12-24V 80 Led Einn bolti sem festir 279x165x61mm 
---	--	---	--

	066 WL183D Vinnuljós með stækkunargleri Model No: WL183D 230V LEDs: 18 SMD Supply: 230V 	
--	--	--

LJÓTABRETTI Á KERRU
KERRULJÓS

482 203017-LED

Ljósabretti LED / pokuljós 12V

8metra snúra.



066 TB3/2

Ljósabretti

92 cm á lengd

12V

2 metra kapall

7 pinna

066 TB0212

Ljósabretti

2 stk/pk

12V

10 metra kapall

7 pinna



285x190mm

066 TB4/5

Ljósabretti

120cm á lengd

12V

5 metra kapall

7 pinna

066 TB4/5LED

Ljósabretti

122cm á lengd

12V

5 metra kapall

7 pinna.



1200x193mm



1220mm á lengd.

482 303045-PVC

 Kapall 7 víra
framlenging
með tengjum.

4 metrar



482 203019-LED

 Kerruljósasett m/segli, þar
Led ljós, 7,5m kapall

297 800306-KIT 12-24V

Kerruljós led þar.

145x163x63mm



066 TB18LEDMAG

Afturljós Led

12V

Með segli



482 304005

Kerrukapall

 7x0,75mm²

50metrar á rúllu



482 303038

Tester fyrir

7 pin





066 TST22

Prufutæki fyrir

13 og 7pinna



KERRUTENGI 7 PÓLA
KERRUTENGI 7 PÓLA

	482 303020	Kerrutengi 7 póla Svart hann		482 303021	Kerrutengi 7 póla Ál hann
	066 TB06	Kerrutengill 7póla Ál hann		470 117500	Kerrutengi 7 póla Ál hann
	482 303031	Kerrutengill 7póla Ál hann 24V		299 P713	Framlenging úr 7 pinna litlum í sjö pinna stórt 1 meter á lengd Hún - Hann
	482 303025	Kerrutengi 13 póla Svart hann		482 303039	Breytistykki 13 póla í 7 pinna
	482 303039-K	Breytistykki 13 póla í 7 pinna Stutt		482 303049	Breytistykki 7pinna í 13 pinna

KERRUTENGI 7 PÓLA HÚS
KERRUTENGI 7 PÓLA HÚS

	482 303022	Kerrutengi 7 póla Svart hún		482 303023	Kerrutengi 7 póla Svart hún Með tengi fyrir þokuljós
	482 303022-C	Gúmmí-hlíf á Tengidós		482 303024	Kerrutengi 7 póla Ál hún
	482 303026	Kerrutengi 13 póla Svart hún		066 TB08	Kerrutengi 7 póla Ál hún
	470 118510	Kerrutengi 7 póla Ál hún		482 303034	Kerrutengi 7 póla Ál hún 24V
	066 TB61	Millilegg undir kerrutengi		482 303040	Tengjasett hún 7 póla Fyrir vagna.
	066 TB38	Lás fyrir dráttarbeisli Universal fitting Ø50mm tow ball lock expands in coupler to prevent towing away. Quick and easy to install. Non-corrosive.		066 TB45	Dráttarkúlulús Universal fitting Ø50mm tow ball trailer hitch lock. 12mm Steel bar and cast steel body helps protect against trailer and caravan theft. Easy to install and remove.

TENGIMYND 7 PINNA
TENGIMYND 7 PINNA

1 Gulur	Vinstra stefnuljós
2 Blár	Inni - Bakk og Þokuljós
3 Hvítur	Jörð
4 Grænn	Hægra stefnuljós
5 Brúnn	Hægra afturljós, -Númers & Stöðuljós
6 Rauður	Bremsuljós
7 Svartur	Vinstra afturljós, -Númers & Stöðuljós

TENGIMYND 13 PINNA
TENGIMYND 13 PINNA

1 Fjólublár	Vinstra Stefнулjós
2 Blár	Þokuljós / Frjálst
3 Hvítur	Jörð fyrir lið 1. til 8.
4 Svart/Hvítur	Hægra Stefнулjós
5 Brúnn	Hægra Afturljós og númerljós
6 Rauður	Bremsuljós
7 Svartur	Vinstra afturljós og númerljós
8 Svart/Gulur	Bakkljós
9 Rauður/Svart	Straumforði - Stöðugur straumur +
10 Svart/Hvítur	Hleðsla fyrir rafgeymi - kveikjukerfi +
11 Frjálst	Laus * ekki notaður
12 Frjálst	Laus * ekki notaður
13 Hvítur	Jörð fyrir lið 9. til 12.

HLEÐSLUTÆKI FYRIR SÍMA
HLEÐSLUTÆKI FYRIR SÍMA

440 871125229950
Hleðslutæki USB síma



440 871125273047
USB Hleðslutæki 12V Dual

440 871125208563
Hleðslutæki 4 USB ÚTTÖK
220V



2 Úttök 2,1A
2 Úttök 1,0A

LJÓ SABORÐI

440 871125243379
LJÓ SABORÐI LED 2M 12V/24V
60 LED 12/24V M/FJARSTÝRINGU





























VASALIÓS
VASALIÓS

 <p>032 700S7 Vasaljós Penni Led Rafhlöður fylgja 2W 110 Lumen 2 x AAA Rafhlöður 135x15mm IP65</p> 	 <p>030 4821109 Vasaljós Penni Led 1W 100 Lumen 2 x AAA Rafhlöður 138x16mm</p> 
 <p>066 HT054 Vasaljós Penni led Hlaðanlegt USB-12V 100/10lm 170mm 3 Litir</p> 	 <p>066 LED043 Vasaljós Penni Led 0,5W 50 Lumen 2 x AAA Rafhlöður 130mm</p> 
 <p>066 LED450 Vasaljós Led 20W Hlaðanlegt USB 2000 Lumen Vinnudrægni 500metrar</p> 	 <p>066 LED011 Vasaljós Penni Led 1W 70 Lumen 2 x AAA Rafhlöður 145mm</p> 
 <p>032 700S8 Vasaljós Led 10W Hlaðanlegt 12-230V 814 Lumen Hleðslurafhlaða USB 146x27mm IP65</p> 	 <p>032 60032 Vasaljós Led P60 Rafhlaða fylgir 60 Lumen 1 x AA Rafhlaða 107x20mm</p> 
 <p>066 LED050 Vasaljós Led 1W Vatnshelt IP67 90 Lumen 2 x AA Rafhlöður</p> 	 <p>066 LED051 Vasaljós Led 3W Vatnshelt IP67 120 Lumen 2 x D Rafhlöður</p> 
 <p>032 700S5 Vasaljós Led 3W Rafhlöður fylgja 320 Lumen 3 x AAA Rafhlöður 110x26mm IP65</p> 	 <p>032 700S1 Vasaljós Led 3W Rafhlöður fylgja 420 Lumen 4 x AAA Rafhlöður 122x30mm IP65</p> 
 <p>032 700P610 Vasaljós Led 10W Rafhlöður fylgja 83/610Lumen 4 x AAA Rafhlöður 125x37mm IP45</p> 	

<p>066 LED072 Vasaljós Led 3W með verkfærum Öryggihamar, vasaljós og smá verkfæri 3xAAA Rafhlöður</p>  	<p>066 LED438 Handljós 10W Led Tvær stillingar 850/280 Lumen Hlaðanlegt</p>  
---	---

 <p>066 LED700PR Vinnuljós m/segli 3 stillingar 100/350/700 Lumen</p> 	 <p>066 LED185W Húfa með Led ljósi Hlaðanlegt USB Heyrnartól og bluetooth</p> 
 <p>066 VS6021 Útfjólublátt ljós Hlaðanlegt Fyrir leit á leka úr kælikerfi og fl.</p> 	 <p>066 LED185 Húfa með Led ljósi Hlaðanlegt USB</p> 

VINNULJÓS-HANDLJÓS
VINNULJÓS-HANDLJÓS

	<p>066 LED1001 Handljós Led 8W Sveigjanlegt 360° Hlaðanlegt USB 100 Lumen IP54</p> 		<p>030 4821111 Handljós Led 3W 3 x AA Rafhlöður Með krók/segli 120 Lumen 226x60x47mm</p> 
	<p>032 14025A Handljós Led 3W Sveigjanlegt 90° Hlaðanlegt 350 Lumen IP54 280mm PRO C2</p> 		<p>030 4821112 Handljós Led 1W 3 x AA Rafhlöður Með krók 90 Lumen 195x62,5x35mm</p> 
	<p>066 LED027 Handljós Led 3W Hleðsluljós. 250 Lumen IP43 320mm</p> 		<p>066 LED042 Handljós Led 12 SMD Led 200 Lumen 300mm</p> 
	<p>066 LED360 Handljós Led 3W 360°Snúningur Lumen 400 Hleðsla micro USB 280mm</p> 		<p>066 LED3601 Handljós Led 2W 360°Snúningur Svart Hleðsla micro USB 170mm</p> 
	<p>066 LED3601G Handljós Led 2W 360°Snúningur Grænt Hleðsla micro USB 170mm</p> 		<p>066 LED3601R Handljós Led 2W 360°Snúningur Rautt Hleðsla micro USB 170mm</p> 
	<p>066 LED3602CAMO Handljós Led 3W 360°Snúningur Hleðsla micro USB 270mm</p> 		<p>066 LED3604 Handljós Led 360° Hleðsluljós Lithium Lumen (600/50)/120lm 400mm</p> 
	<p>066 LED3604G Handljós Led 360° Hleðsluljós Lithium Lumen (600/50)/120lm 400mm</p> 		<p>066 LED3604R Handljós Led 360° Hleðsluljós Lithium Lumen (600/50)/120lm 400mm</p> 



ENNISLJÓS
ENNISLJÓS

	<p>066 HT03LED Ennisljós Led 3 x AAA Rafhlöður fylgja 10 Lumen</p> 		<p>066 LED360HT Ennisljós Led 2W Hlaðanlegt USB Tvær stillingar 160/60 Lumen</p> 
	<p>032 700H8 Ennisljós Led 3W 3 x AAA Rafhlöður 3 Stillingar 180 Lumen IP44 PRO H8</p> 		<p>066 HT103LED Ennisljós Led 3W 3 x AAA Rafhlöður 100 Lumen</p> 
	<p>066 HT107LED Ennisljós Led 5W 3 x AA Rafhlöður 5W CREE XPG 300 Lumen Með birtustilli.</p> 		<p>066 HT111LED Ennisljós Led 5W 3 x AA Rafhlöður 350Lm og 80 Lm</p> 
	<p>032 700H1 Ennisljós Led 5W 3 x AAA Rafhlöður 2 Stillingar 365 Lumen IP44 PRO H1</p> 		<p>066 HT101 Ennisljós Led 3W 3 x AAA Rafhlöður 200 Lumen</p> 
	<p>066 HT110 Ennisljós Led 3W Vasaljós fylgir 170 Lumen</p> 		<p>066 HT108LED Ennisljós Led 5W Hlaðanlegt 2 Stillingar 360/100 Lumen USB og Hreyfiskynjari.</p> 
			<p>032 700H2-R Ennisljós Led Hlaðanlegt 2 Stillingar 420 Lumen IP65 PRO H2-R</p> 



LJÓSAHUNDUR

TJALDLUKT

032 18101A Ljósahundur 11W
360 Lumen 5m Kapall
220-240V
11W G23 pera 400x44 Með krók

660 LNT-100 Tjaldlukt LED
95Lumen 16 LED PERUR
3xD Rafhlöður, fylgja ekki með.
230X114X112mm





482 509048
Loftdæla 12V 150psi
80ltr á mín





LOFTDÆLA 12V
066 MAC01 Loftdæla 12V 120psi
25ltr á mín.

Model No:	MAC01
Hose Length:	600mm
Power Cord Length:	3.3mtr
Operating Voltage:	12V

066 TP80 Olíudæla fyrir
5-20ltr brúsa
9ltr/mín





2x AA rafhlöður





066 MAC07 Loftpressa míní 12V
95ltr á mín

Model No:	MAC07
Hose Length:	7500mm
Power Cord Length:	3mtr
Operating Voltage:	12V
Typical Inflation Time:	0-30psi in 45sec (175/70/R13)
Maximum Current:	40A
Maximum Pressure:	150psi



066 TP94 Olíutunnudæla 12V

Model No:	TP94
Voltage:	12V
Current:	4.5A
Duty Cycle:	15min/hr
Flow Rate:	16.5ltr/min





066 TP9424 Olíutunnudæla 24V



Model No:	TP9424
Voltage:	24V
Current:	3.5A
Duty Cycle:	15min/hr
Flow Rate:	15ltr/min

482 502002 Rúðusprautudæla
Universal 12V

482 502003 Rúðusprautudæla
12V





440 871125207659 Fjölengi hvítt m/rofa
3.tengl.



066 STF42 Vifta 3ja hraða 42"
230V

Model No:	STF42
Speeds:	3
Oscillation:	Yes
Supply:	230V
Power:	55W
Height:	1065mm

FJÖLTENGI 230V

RAFVIRKJAHANSKAR 1000V

440 871125256672 Fjöltengi hvítt m/rofa 4. tengl.



066 HVG1000VL Rafvirkjahanskar







LJÓSAPERA LED 230V

Bluetooth hátalari

066 LED060 Ljósapera LED 10W
6500K White light E27
810 Lumen
30.000 Klukkutíma ending.

066 SB1 Hátalari þráðlaus
790gr.



Hlaðanlegur með USB snúru

HLEÐSLUTÆKI

066 SDC150 Hleðslutæki 6-12V



Model No:	SDC150	240V
Output:	12/24V	
Output Charge Peak:	15A	
Battery Range:	20-100Ah	
Supply:	230V	



HLEÐSLUTÆKI

066 AUTOCHARGE12S



Hleðslutæki 12/24V
230V
12 amp hleðsla

Geymastærð 10-60 Ah



066 SPI3S Hleðslutæki 6/12V



Model No:	SPI3S	3A
Output:	12V	
Output Charge:	3A	
Battery Range:	Lead Acid 12-50Ah, LiFePO4 3-50Ah	
Cable Length:	2mtr	
Supply:	230V	
Weight:	0.8kg	
IP Rating:	IP64	

Fyrir LITHIUM hleðslu



066 SPI15S Hleðslutæki 6/12V



Model No:	SPI15S	15A
Output:	12V	
Output Charge:	15A	
Battery Range:	Max. 230Ah Lead Acid	
Cable Length:	1.8mtr	
Supply:	230V	
Weight:	1.5kg	
IP Rating:	IP20	

Fyrir LITHIUM hleðslu



066 CHARGE110

Hleðslutæki 12/24V



Model No:	CHARGE110
Output:	12/24V
Output Charge Peak(EN):	14A(10A)
Battery Range:	20-120Ah
Input Charge:	0.9A
Charging Rates:	2
Supply:	230V
Polarity Protection:	Fuse (1 x 20A)



066 SUPERCHARGE40/1

Hleðslutæki 12/24V



Model No:	SUPERCHARGE40/1
Output:	12/24V
Output Charge Peak(EN):	18A(12A)(12V), 12A(8A)(24V)
Battery Range:	30/225Ah(12V), 20/180Ah(24V)
Input Charge:	1A
Charging Rates:	2
Supply:	230V
Polarity Protection:	Fuse (1 x 20A)
Consumable Parts:	SBF2050 (Pack of 50) - Fuse



066 BSCU25

12/24V

Hleðslutæki/Vaktari



Model No:	BSCU25
Type:	9-Cycle with Support
Input Voltage:	230V
Input Current:	2.4A
Charging Voltage:	12V/24V
Charging Current 12V:	25A
System:	
Charging Current 24V:	12.5A
System:	
Battery Support Mode:	<300W



066 AUTOCHARGE100HF

Hleðslutæki 1A 6/12V



Battery range
0.8-14Ah



066 AUTOCHARGE200HF

Hleðslutæki 2A 6/12V



Battery range
1.3 - 60 Ah



066 AUTOCHARGE1200HF

Hleðslutæki 12A 12/24V



Battery range
1.3 - 400 Ah



066 SMC11

Hleðslutæki/Vaktari
12V



Model No:	SMC11
Specification Table:	
Type:	3-Cycle 12V
Supply:	230V
Output:	12V
Input Current:	0.25A
Efficiency:	>80%
Charging Current:	0.8A
Back Current Drain:	<1Ah/month
Ambient Temperature:	-20°C to +50°C
Dimensions (W x D x H):	178 x 66 x 38mm
Housing Protection:	XXX
Weight:	0.4kg



066 SL65S

Hleðslutæki Lithium



Model No:	SL65S
Maximum Current:	400A
Voltage:	12V
Auxiliary Output:	USB (x2) - 5V/2.1A, 5V/1A
Cable & Clamp Length:	430mm
Size (W x D x H):	78 x 25 x 125mm
Weight:	285g
Maximum Starting Capacity:	2ltr Petrol/1.6ltr Diesel
Capacity:	800mAh



066 SL66S

Startkapall fyrir
SL65S



Model No:	SL66S	SL65S
Length:	640mm	
Application(s):	SL1S, SL65S	



HLEÐSLUTÆKI

066 SMC12

Hleðslutæki/Vaktari

230V 12V
1,5A

3-Cycle 12V

IP65

0.49kg



198 x 68 x 41mm



HLEÐSLUTÆKI

066 SMC13

Hleðslutæki/Vaktari

230V 6/12V
4A

9-Cycle 6/12V

IP65

0.66kg





242 x 82 x 53mm



STARTTÆKI
STARTTÆKI



066 E/START800 Starttæki
Rafhlöðulaust starttæki 12V

Model No:	E/START800
Output:	12V
Output Start Peak(EN):	800A(400A)

066 E/START1600 Starttæki
Rafhlöðulaust starttæki 12V

Model No:	E/START1600
Output:	12V
Output Start Peak(EN):	1600A(800A)





066 E/START1224 Starttæki
Rafhlöðulaust starttæki 12/24V

Model No:	E/START1224
Output:	12/24V
12V Output Start Peak(EN):	1000A(500A)
24V Output Start Peak(EN):	1600A(800A)





066 RS132 Starttæki 12V
með loftdælu/ljós.
900 Peak Amps.
400 Cold Cranking Amps.
Kapall 720mm langir





066 RS131 Starttæki 12V

Model No:	RS131
Cold Cranking Amps:	250A
Peak Amps:	750A
Voltage:	12V
Auxiliary Output:	5V/2.1A USB (x2), 12V
Cable & Clamp Length:	780mm
Integral Air Compressor:	-
Maximum Pressure:	-
Weight:	5.9kg



066 RS1B Starttæki 12V
900 Peak Amps.
200 Cold Cranking Amps.
Fyrir fólksbíla 4 cyl, 2 ltr

066 START320 Start/hleðslutæki
12/24V

Model No:	START320
Specification Table:	
Output:	12/24V
Output Charge Peak(EN):	45A(30A)
Output Start Peak(EN):	320A(220A)
Battery Range:	30-500Ah
Input Charge:	5A
Input Start:	20A
Charging Rates:	3
Supply:	230V
Polarity Protection:	Fuse (1 x 110A)

066 START360.F Öryggi



066 PP1 Bilanagreinir auto
6-24V

- A brilliant tool for the auto electrician and mechanic.
- Carry out the following tests on systems from 6V up to 24V quickly and efficiently:









066 VS6021 Útfjólublátt ljós
Hlaðanlegt
Fyrir leit á leka úr
kælikerfi og fl.



066 PROSAF/12 Rafgeymavörn
Rafsuðu 12V

066 PROSAF/24 Rafgeymavörn
Rafsuðu 24V

066 S01001 Rafsuðuhjálmur
Vinnuhiti -5°C til +60°C
Þyngd 515gr
Solarsella
Operating time light/dark 0.01ms
Shade Active : 9-13 Variable

066 VS027 Bremsuökvamælir

Model No:	VS027
Moisture Content:	
Green:	<0.5%
Yellow:	0.5-3.5%
Red:	>3.5%

- Easily calibrated using new brake fluid.
- Audible test cycle with three LED read-out.
- Just insert probe and press button for immediate result.
- Works on DOT 3, 4 and 5.1 specification fluids.
- Powered by a 9V battery (not included).



RAFSUÐUTÆKI
066 INVMIG200LCD Rafsuðuvél MIG

Model No:	INVMIG200LCD	230V
Specification Table:		200Amp
Duty Cycle:		
MIG:	20% @ 200A, 100% @ 89A	
TIG:	20% @ 180A, 100% @ 80A	
MMA (Arc):	20% @ 180A, 100% @ 80A	
Wire Capacity:	5kg	
Electrode Capacity:	Ø1.6-4mm	
Absorbed Power:	8.6kW	
Supply:	230V	
Insulation:	IP21S	
Protection:	H	
Weight:	20kg	
MIG Torch:	Euro Non-Live BINZEL® MB15*	
MMA Accessory Kit (Optional):	MMA01	
TIG Accessory Kit (Optional):	TIG10S	
Note:	*Included as standard	

RAFSUÐUTÆKI
066 SUPERMIG230 Mig Suðuvél

Model No:	SUPERMIG230
Welding Current:	30-230A
Wire Capacity:	5-15kg
Duty Cycle:	100% @ 68A, 60% @ 88A, 15% @ 175A
Cooling System:	Forced Air
Spot Welding Timer:	Yes
Gas Type:	CO2, Argon, CO2/Argon Mix
Torch:	3mtr Euro Non-Live - BINZEL® MB15
Supply:	230V
Absorbed Power:	8kW
Case Size:	Large
Weight:	49.5kg

066 MGC946 Jarðtengill segull 250Amp

Model No:	MGC946
Specification Table:	
Rated:	250A
Base Size:	Ø85mm

066 PP40H Plasmaskurðarvél 40 Amp

Model No:	PP40H
Specification Table:	
Power Output:	15-40A
Duty Cycle:	35% @ 40A, 60% @ 30.5A, 100% @ 23.6A
Maximum Cutting Thickness:	15mm
Air Requirements:	300ltr/min
Working Pressure:	45-70psi
Absorbed Power:	6.4kW
Supply:	230V
Insulation:	H
Protection:	IP21S
Weight:	11.3kg
Replacement Consumables:	
Electrode, Short (Pack Qty):	PP40H.V2.E (x5)
Nozzle, Short (Pack Qty):	PP40H.V2.N (x5)
Diffuser (Pack Qty):	PP40H.V2.D (x5)
Safety Cap (Pack Qty):	PP40H.V2.SC (x2)

066 PWH2 Rafsuðuhjálmur Vinnuhiti -5°C til +55°C Þyngd 535gr

Solarsella

 Operating time light/dark 0.04ms
 Shade Active : 9-13 Variable

066 MIGHTYMIG100 Rafsuðuvél Mig

3KW 100Amp
Gas laus 230V
Fluxvír

Aukavír = 066 TG100/1

066 VS240 Spanhitari 1000W

Model No:	VS240
Contents:	VS2303 - Direct Coil - Ø20mm, VS2307 - Direct Coil - Ø32mm, VS2309 - Pad Coil - Ø55mm, VS2410 - Flex Coil - 830mm
Frequency:	50/60Hz
Power:	1000W
Supply:	230V

066 VS230 Spanhitari 2000W 230V

Model No:	VS230
Contents:	
VS2303:	Direct Coil - Ø20mm
VS2305:	Direct Coil - Ø30mm
VS2304:	Side Coil - Ø20mm
VS2306:	Side Coil - Ø30mm
VS2309:	Pad Coil - Ø55mm
VS2310:	Flex Coil - 740mm
VS2311:	Induction Block - 50 x 35 x 30mm
Supply:	230V
Frequency:	50/60Hz
Power:	2000W

 Fullt af stökum aukahlutum .
 15mm - 32mm göt .

066 WE1020 Rafsuðuvír 2,0mm

Model No:	WE1020
Size:	Ø2 x 300mm
Welding Current:	40-60A
Pack Quantity:	10

066 WE1025 Rafsuðuvír 2,5mm

Model No:	WE1025
Size:	Ø2.5 x 300mm
Welding Current:	55-100A
Pack Quantity:	10

066 WE1032 Rafsuðuvír 3,2mm

Model No:	WE1032
Size:	Ø3.2 x 350mm
Welding Current:	90-130A
Pack Qty:	10

066 VS2301 Hitaelement snúið Beint 15mm

066 VS2303 Hitaelement snúið Beint 20mm

066 VS2305 Hitaelement snúið Beint 28mm

066 VS2307 Hitaelement snúið Beint 32mm

066 VS2309 Hitaelement snúið Púði 55mm

066 VS2311 Hitaelement kubbur 50x30x35mm

066 VS2302 Hitaelement snúið Hliðar 15mm

066 VS2304 Hitaelement snúið Hliðar 20mm

066 VS2306 Hitaelement snúið Hliðar 28mm

066 VS2308 Hitaelement snúið Hliðar 32mm

066 VS2310 Hitaelement snúra 740mm

066 PW1500 Háþrýstidæla
105bar
1400 W
230V 13A
300ltr/hr
SEALEY



066 PW1600 Háþrýstidæla
110bar
230V
Model No: PW1600
Maximum Pressure: 110bar(1600psi)
Effective Cleaning Power: 187bar(2720psi)
Water Flow: 318ltr/hr
Motor Power: 1300W
Supply: 230V - 13A
Total Stop System: Yes
Rotablast Nozzle®: Yes
Hose Length: 5mtr
Weight: 7.7kg
SEALEY



066 PW1750 Háþrýstidæla
120 bar
230V
Model No: PW1750
Maximum Pressure: 120bar(1750psi)
Effective Cleaning Power: 205bar(2975psi)
Water Flow: 360ltr/hr
Motor Power: 1400W
Supply: 230V - 13A
Total Stop System: Yes
Rotablast Nozzle®: Yes
Hose Length: 5mtr
Weight: 13.5kg
SEALEY



066 PW2000 Háþrýstidæla
140bar
230V
Model No: PW2000
Maximum Pressure: 140bar(2030psi)
Effective Cleaning Power: 257bar(3740psi)
Water Flow: 402ltr/hr
Motor Power: 1700W
Supply: 230V - 13A
Total Stop System: Yes
Rotablast Nozzle®: Yes
Hose Length: 5mtr
Weight: 19.5kg
SEALEY



066 GV180WM Ryksuga á vegg
1500W
230V
18lítra
Bílskýrsryksuga á vegg.
Fyrir blautt og þurr.
SEALEY



066 PC460 Ryksuga "wet & dry"
230V
Model No: PC460
Motor Power: 1600W
Supply: 230V
Drum Size: 60ltr
Drum Type: Stainless Steel
Weight: 16kg
Vacuum Accessories Ø: 38mm
Filter Type: Cartridge
Replacement Cartridge Filter: PC200CFL
Replacement Foam Filter: PC460.ACC7
SEALEY



066 PC102 Ryksuga 1000W
1000W
230V
10lítra
Fyrir blautt og þurr.
SEALEY



066 PC200SD Ryksuga 1250W
1250W
230V
20lítra
Fyrir blautt og þurr.
SEALEY



482 504041 Þvottakar 75,7ltr
m/dælu
230V
REAL-PARTS HOLLAND



066 SM28 Þvottakar m/dælu
230V
á hjólum.
Model No: SM28
Overall Height: 898mm
Tank Height: 260mm
Tank Width: 540mm
Tank Length: 810mm
Pump Output/hr: 200ltr
Motor Power: 25W
Supply: 230V
Weight: 32kg
Maximum Working Capacity: 50ltr
Minimum Working Capacity: 40ltr
SEALEY



066 SCT09 Ultrasonic Þvottavél
Min 5ltr Max 9ltr
230V
Hitastig upp í 80°C
200W
Stærð 410x270x310mm
Þvottakar 300x240x150mm
Tími upp í 99mín
SEALEY



482 504042 Þvottakar 151 ltr
m/dælu
230V
REAL-PARTS HOLLAND



482 504047 Sandblástursskápur
220 ltr
230V
REAL-PARTS HOLLAND



482 504048 Sandblástursskápur
440 ltr
230V
REAL-PARTS HOLLAND



482 504056 Sandblástursskápur
990 ltr
230V
REAL-PARTS HOLLAND



066 BGT25KG Sandblásturssandur 25kg
á borð
230V
REAL-PARTS HOLLAND

RAFMA GNSVERKFÆRI
RAFMA GNSVERKFÆRI

066 SD1530 Lóðbolti 15/30V
230V



Ergonomic handle design with comfortable grip, LED indicator and three position switch. Dual wattage settings allow the user to carry out work requiring different temperatures. Fitted with high quality long life tip suitable for lead free soldering and 1.3mtr cable with BS approved 230V/13Amp plug. Features knurled collar for quick and convenient tip



066 SD4080 Lóðbolti 40/80V
230V



Ergonomic handle design with comfortable grip, LED indicator and three position switch. Dual wattage settings allow the user to carry out work requiring different temperatures. Fitted with high quality long life tip suitable for lead free soldering and 1.3mtr cable with BS approved 230V/13Amp plug.



066 SD300K Lóðbyssusett 8 stk
230V
100W

066 SD250K Lóðbolti 30/100W
230V



Model No: SD250K
Contents: 30/100W Dual Powered Pistol Type Soldering Gun, Soldering Wire, Solder Sucker, Metal Safety Stand with Cleaning Sponge
Temperature Range: 120°C to 250°C



066 ST80 Lóðboltastöð PRO
230V
80W



Model No: ST80
Supply: 230V
Frequency: 50Hz
Heating Element Voltage: 28V AC
Temperature Stability: ±2°C (in still air, no load)
Temperature Accuracy: ±10°C
Temperature Range: 150-480°C(302-896°F)
Tip-to-Ground Resistance: < 2Ω
Tip-to-Ground Voltage: < 2mV
Power: 80W



066 SDL6 Lóðbolti hlaðanlegur
3,7V



RECHARGEABLE

Model No: SDL6
Battery: 3.7V 2.6Ah Li-Ion
Power Rating: 6W
Maximum Temperature: 510°C
Charging Time: 3-4hr
Operating Time: 90min
Consumable Parts: Conical Tip; SDL6.CT, Flat Chisel Tip; SDL6.FT



066 HVLP3000 Sprautukanna 700W
230V



Model No: HVLP3000
Power: 700W
Maximum Air Pressure: 4.35psi
Voltage: 230V
Spray Gun Set-Up: 2.5mm
Pot Capacity: 800ml
Air Hose Length: 3mtr
Weight: 3kg



066 AK2920 Límbyssa 80W 230V
230V



Model No: AK2920
Power: 80W
Supply: 230V
Replacement Glue Sticks:
Model No: AK292/2 Pack Quantity: 25pc

066 AK292/2 Límstautar 25 stk



066 SMS2101 Brýni 200mm 180W
230V



Model No: SMS2101
Motor Power: 180W
Supply: 230V
Wheel Diameter: Ø200 x 40mm
Axle Diameter: Ø12mm
No Load Speed: 95rpm
Weight: 11.8kg
Grinding Stone: Ø200 x 40mm
Leather Honing Wheel: Ø200 x 30mm
Replacement Wheels:
Sharpening Wheel: SMS2101.SW
Honing Wheel: SMS2101.HW



066 SMS2003 Brýni f/hjólsagarbl.
110W 230V
5300rpm 0-25°
Blað 90-400mm
5kg.





066 SMS2008 Borabrýni 80W
230V



Model No: SMS2008
Motor Power: 80W - 230V
Free Speed: 4200rpm
Drill Bit Range: Ø3-13mm



066 BG1010 Smergel Mini 50mm
230V



Model No: BG1010
Motor Power: 100W
Supply: 230V
Wheel Diameter: Ø50mm
No Load Speed: 3000-9000rpm
Weight: 7.5kg



066 SM521 Smergel og brýni
230V



Model No: SM521
Motor Power: 250W
Supply: 230V
Wet Grinding Stone Size: Ø200mm
Wet Grinding Stone Model: SMS21GW200W
No:
Wet Grinding Speed: 130rpm
Dry Grinding Stone Size: Ø150mm
Dry Grinding Stone Model No: BG150/15 (Fine), BG150/16 (Coarse)
Dry Grinding Speed: 2850rpm
Weight: 11.7kg



066 BG150XW/99 Smergel 150mm
Heavy Duty 230V
Með vírskífu



450W
2850rpm

SEALEY

066 BG200/99 Smergel 200mm
Heavy Duty 230V



600W
2850rpm

SEALEY

066 BG150XL/96 Smergel 150mm
230V



Model No:	BG150XL/96
Supplied with:	2 x Stones
Motor Power:	370W
Supply:	230V
Axle Diameter:	13mm
No Load Speed:	2850rpm
Weight:	12kg

SEALEY

066 BG150XLW/98 Smergel 150mm
230V



Model No:	BG150XLW/98
Specification Table:	
Supplied with:	Stone, Wire Wheel
Motor Power:	370W
Supply:	230V
Axle Diameter:	Ø13mm
No Load Speed:	2850rpm
Weight:	11kg

SEALEY

066 BG150XD/99 Smergel 150mm
230V



Model No:	BG150XD/99
Supplied with:	Stones (x2)
Motor Power:	450W
Supply:	230V
Axle Diameter:	Ø13mm
No Load Speed:	2850rpm
Weight:	13kg

SEALEY

066 BG200XL Smergel 200mm
230V



Model No:	BG200XL
Supplied with:	2 x Stones
Motor Power:	600W
Supply:	230V
Axle Diameter:	16mm
No Load Speed:	2850rpm
Weight:	17kg

SEALEY

066 BG150BS Smergel og slípiband
230V



Model No:	BG150BS
Motor Power:	250W
Supply:	230V
Belt Size:	50 x 686mm
Belt Speed:	895mtr/min
Stone Size:	150mm
Stone Speed:	2850rpm
Table Tilt:	45°
Weight:	10kg

SEALEY

066 SM750 Slípivél
230V



Model No:	SM750
Belt Size:	762 x 25mm
Belt Speed:	845mtr/min
Disc Size:	125mm
Disc Speed:	2850rpm
Table Size (W x D):	128 x 185mm
Table Tilt:	0-45°
Motor Power:	250W - 230V
Supply:	230V
Dust Extraction Ports:	Ø45mm (x2)
Weight:	7kg
Replacement Sanding Belts:	
Model No:	Grade:
SM750B60G	60Grit
SM750B80G	80Grit
SM750B120G	120Grit
Replacement Sanding Discs:	
Model No:	Grade:
SM750D80G	80Grit

SEALEY

066 SM914 Slípivél með bandi
og disk.
230V



Model No:	SM914
Belt Size(s):	100 x 915mm
Belt Speed:	440mtr/min
Disc Ø:	Ø150mm
Disc Speed:	2850rpm
Table Size:	225 x 160mm
Table Tilt:	0-45°
Motor Power:	370W
Supply:	230V
Dust Extraction Ø:	Ø63.5mm
Weight:	18.5kg
Consumable Parts:	
Replacement Sanding Belts:	
Model No:	Grade:
SM14/B060G	60Grit
SM14/B080G	80Grit
SM14/B100G	100Grit
Replacement Sanding Disc:	
Model No:	Grade:
SM14/D80G	80Grit

SEALEY

066 SM1300 Slípivél með hólkum
230V



Model No:	SM1300
Motor Power:	450W - 230V
No Load Speed (Spindle/Belt):	2000/1750rpm
Oscillations:	600pm
Belt Size:	610 x 102mm
Spindle Height:	102mm
Table Tilt:	0-45°
Table Size:	489 x 483mm
Bobbins Included:	13, 19, 25, 38, 50mm
Dust Extraction Port ID/OD:	Ø36/39mm
Weight:	18kg

SEALEY

Slípihólkur fyrir slípivél SM1300

066 SM1300B13	Ø13 x 90 80 GRIT
066 SM1300B19	Ø19 x 90 80 GRIT
066 SM1300B25	Ø25 x 90 80 GRIT
066 SM1300B38	Ø38 x 90 80 GRIT
066 SM1300B50	Ø50 x 90 80 GRIT
066 SM1300B610	610X100 80 GRIT

Rafmagnsverkfæri

047 64864 Slípirokkur 125mm
1250W 230V

3M
Rafmagnsverkfæri

066 SRS850 Rafmagnssög
850W 230V
Bláðlengd 150mm

SEALEY

024 SE-204 Slípivél rafmagns
MBX 23/11mm
230V

MONTI

024 SE-206-BMC Slípivél rafmagns
Sett m/bustum MBX 23/11mm
230V

MONTI

066 SO125 Slípari 125mm
230V



Model No: S0125
Pad Size: Ø125mm
Power: 240W
Supply: 230V
No Load Speed: 12000rpm
Orbit Size: Ø3mm
Weight: 1.17kg

SEALEY

066 SD1000 Höggborvél 13mm
230V



Model No: SD1000
Capacity: 13mm
Motor Power: 1050W
Supply: 230V
No Load Speed: 0-1100/0-3000rpm
Hammer Action: 0-17600/0-48000bpm
Drilling Capacities:
Wood: 25mm
Steel: 13mm
Masonry: 16mm
Weight: 4kg

SEALEY

047 64392 Massavél 1100W
230V

3M

066 MS900PS Massavél 1300W
230V



Model No: MS900PS
Pad Size: Ø170mm
Thread Size: M14 x 2mm
No Load Speed: 1400-3000rpm
Power: 1300W
Supply: 230V
Weight: 3.8kg

SEALEY

066 ER230P Bónvél 230mm
230V



Model No: ER230P
Supply: 230V
Power: 110W
Speed: 3300rpm
Pad Size: Ø230mm
Cable Length: 4mtr
Replacement Backing Pad: ER230P.BPV2
Replacement Bonnet Terry Cloth: ER230P.TB
Replacement Bonnet Synthetic Fleece: ER230P.WB

SEALEY

066 ER150P Bónvél 150mm
230V
60W

SEALEY

066 E5188 Slípari 230V m/barka
230V



Model No: E5188
Power - Supply: 170W - 230V
Speed Range: 8000-35000rpm Stepless
Collets: 1.5mm, 2.3mm (x2), 3.2mm
Twist Drills: 1.5mm (x2), 2.3mm (x2), 3.2mm (x2)
Mounted Points: 10pc
Diamond Tipped Engravers: 5pc
Sanding Cylinder: 6.4 x 12.7mm, 12.7 x 12.7mm

SEALEY

066 SMT300Q Fjölnota verkfæri
230V



Model No: SMT300Q
Motor Power: 300W
Supply: 230V
No Load Speed: 15000-21000rpm
Weight: 1.48kg

Cutting Blade, Scraper Blade, Sanding Discs (x4), Triangle Backing Pad

SEALEY

066 HS102K Plastviðgerðarsett
með hitabyssa



Model No: HS102K
Contents: HS102 Hot Air Gun, Plastic Welding Nozzle, Reduction Nozzle, Starter Pack of ABS Rods

SEALEY

066 HS100 Hitabyssa 2000W
230V



Model No: HS100
Power: 2000W
Supply: 230V
Temperature Range: 50/420/650°C
Airflow: 250, 400, 650ltr/min

3-Hraða

SEALEY

066 HS105 Hitabyssa 1600W
230V



Model No: HS105
Power: 1600W
Supply: 230V
Temperature Range: 375°C/500°C
Airflow: 300, 500ltr/min

SEALEY

066 HS104K Hitabyssa Delux
230V



Model No: HS104K
Power: 2000W
Supply: 230V
Temperature Range: 80°C/80-600°C
Airflow: 480ltr/min

SEALEY

RAFHLÖÐU-RAFMAGNSTÆKI
066 CP2144MH Skrall 3/8" 14,4V

Model No:	CP2144MH
Battery:	14.4V 2Ah Ni-MH
Drive:	3/8" Sq
Maximum Torque:	48Nm(35lb.ft)
Replacement Battery:	CP2144MHBP
Weight:	2.1kg

RAFHLÖÐU-RAFMAGNSTÆKI
066 CP2400MH Herslulykill 1/2" 24V

Model No:	CP2400MH
Battery:	24V 2Ah Ni-MH
Drive:	1/2" Sq
No Load Speed:	0-2000rpm
Impact Rate:	0-2600bpm
Maximum Torque:	441Nm(325lb.ft)
Replacement Battery:	CP2400MHBP
Weight:	3.6kg

066 CP2144MHBP Rafhlaða fyrir skrall
066 CP2400MHBP Rafhlaða fyrir lykil

066 CP3005 Herslulykill 1/2" 18V

Model No:	CP3005
Battery:	18V 4Ah Li-ion
Drive:	1/2" Sq
No Load Speed:	1900rpm
Impact Rate:	2200bpm
Maximum Torque:	650Nm(480lb.ft)
Replacement Battery:	CP3005BP4
Weight:	3kg

066 CP36S Hleðsluskrúfjárn

Með skrúfbitum og innbyggðu vasaljósi. 53stk Lithium rafhlaða.

066 CP36B Hleðsluskrúfjárn

Model No:	CP36B
Battery:	3.7V 1.3Ah Li-ion
Free Speed:	210rpm
Maximum Torque:	3.5Nm
Charging Time:	3-5hr

Með 24 skrúfbitum.

066 CP36MS Hleðsluskrúfjárn

Model No:	CP36MS
Battery:	3.7V 1.3Ah Li-ion
Free Speed:	0-230rpm
Maximum Torque:	4.5Nm
Charging Time:	3-5hr

Með 14 skrúfbitum

066 RE024 Plastviðgerðarbyssa Hleðslubatterý.

Model No:	RE024
Battery:	3.7V 6600mAh Li-ion
Charging Time:	3-4hr

066 CP6018V Borvél 18V

Model No:	CP6018V
Battery:	18V 1.5Ah Li-ion
No Load Speed:	0-350/0-1400rpm
Impact Rate:	0-4550/16200bpm
Drilling Capacities:	
Wood:	32mm
Metal:	13mm
Concrete:	10mm
Chuck Size:	13mm
Maximum Torque:	50Nm
Replacement Battery:	CP6018VBP
Weight Including Battery:	2.4kg

066 CP18VLD Borvél 18V

Model No:	CP18VLD
Battery:	18V 1.5Ah Li-ion
No Load Speed:	0-350/0-1250rpm
Impact Rate:	0-5250/0-19500bpm
Drilling Capacities:	
Wood:	Ø20mm
Metal:	Ø10mm
Concrete:	Ø10mm
Chuck Size:	Ø10mm
Maximum Torque:	31Nm
Replacement Battery:	CP18VLD BP
Weight Including Battery:	1.25kg

066 CPG18V Smursprauta 18V

Model No:	CPG18V
Battery:	18V 1.7Ah Ni-MH
Pressure:	8000psi
Flow Rate:	100g/min
Hose Length:	700mm
Replacement Battery:	CPG18VBP

066 CP18VLDBP Rafhlaða Lithium F/CP18VLD

Model No:	CP18VLDBP
Battery:	18V 1.5Ah Li-ion
Application(s):	CP18VLD

066 CPG18VBP Rafhlaða 18V F/CPG18V

Model No:	CPG18VBP
Battery Type:	18V 1.7Ah Ni-MH

Fyrir Smursprautu.



SÚLUBORVÉLAR

066 GDM140F Súluborvél á gólf 230V



Model No:	GDM140F
Drilling Capacity (Chuck Size):	16mm
Spindle Nose Taper:	MT2
Swing:	314mm
Spindle Centre to Column:	127mm
Spindle Travel:	60mm
Number of Speeds:	12
Speed Range:	210-2580rpm
Maximum Distance Spindle to Table:	780mm
Maximum Distance Spindle to Base:	1150mm
Working Table Surface Size:	Ø250mm
Working Base Surface Size:	195 x 180mm
Overall Base Size:	420 x 250mm
Column Diameter:	60mm
Collar Diameter:	60mm
Overall Height:	1530mm
Motor Power (Start):	220W (370W)
Supply:	230V
Weight:	53kg
Optional Keyless Chuck 16mm:	GDMX/KC



SÚLUBORVÉLAR

066 PDM170F Súluborvél 16 hraða 230V 1610mm



Model No:	PDM170F
Drilling Capacity (Chuck Size):	16mm
Spindle Nose Taper:	MT2
Swing:	413mm
Spindle Centre to Column:	170mm
Spindle Travel:	80mm
Number of Speeds:	16
Speed Range:	190-3000rpm
Maximum Distance Spindle to Table:	770mm
Maximum Distance Spindle to Base:	1255mm
Working Table Surface Size:	254 x 254mm
Working Base Surface Size:	205 x 200mm
Overall Base Size:	450 x 270mm
Column Diameter:	Ø73mm
Collar Diameter:	Ø55mm
Overall Height:	1610mm
Motor Power:	370W(550W)
Supply:	230V
Weight:	58kg
Optional Keyless Chuck 16mm:	PDM/KC
Integral Work Light (Bulb not Included):	No



066 PH250 Vírtalía 125/250kg 230V



Model No:	PH250
Capacity (single cable):	125kg
Capacity (double cable):	250kg
Lift Height (single cable):	12mtr
Lift Height (double cable):	6mtr
Lift Speed (Maximum):	8mtr/min
Power - Supply:	500W - 230V
Weight:	12.5kg



066 PH400 Vírtalía 200/400kg 230V



Model No:	PH400
Capacity (single cable):	200kg
Capacity (double cable):	400kg
Lift Height (single cable):	12mtr
Lift Height (double cable):	6mtr
Lift Speed (Maximum):	8mtr/min
Power - Supply:	750W - 230V
Weight:	16kg



066 E541 Merkipenni 230V



Model No:	E541
Power - Supply:	13W - 230V
Speed:	6000rpm
Tungsten Carbide Tipped Engraving Heads:	1.8mm
Accessories:	Tungsten Carbide Tipped Engraving Head, Letter Template, Number Template



066 CP2812VCOMBO Slípi og bónsett míni 10,8V

Model No. - Description
 CP2812V - Cordless Mini Sander/Polisher Kit 10.8V
 SCS701 - Cutting Compound Medium 500ml
 SCS702 - Super Polymer Polish 500ml



LOFTPRSSUR
066 SAC00615 Loftpressa 6ltr

Model No:	SAC00615	230V
Motor Output:	1.5hp	
Voltage/Phase:	230V - 1ph	
Minimum Rated Supply:	13A	
Air Displacement	6.35(180)	
cfm(ltr/min):		
Maximum Free Air Delivery	4.7(130)	
cfm(ltr/min):		
Maximum Pressure:	116psi(8bar)	
Receiver Capacity:	6ltr	
Outlet Fitting:	Quick Release Coupling	
Dimensions (W x D x H):	480 x 180 x 490mm	
Weight:	10kg	

LOFTPRESSUR
066 SA5020 Loftpressa 50ltr

Model No:	SA5020	230V
Motor Output:	2hp	
Voltage/Phase:	230V - 1ph	
Minimum Rated Supply:	13A	
Air Displacement	7(200)	
cfm(ltr/min):		
Maximum Free Air Delivery	4.8(135)	
cfm(ltr/min):		
Maximum Pressure:	116psi(8bar)	
Receiver Capacity:	50ltr	
Outlet Fitting:	Quick Release Coupling	
Dimensions (W x D x H):	740 x 400 x 590mm	
Weight:	30kg	

066 SAC05030 Loftpressa 50ltr

Model No:	SAC05030	230V
Motor Output:	3hp	
Voltage/Phase:	230V - 1ph	
Minimum Rated Supply:	13A	
Air Displacement	12.6(357)	
cfm(ltr/min):		
Maximum Free Air Delivery	8.75(248)	
cfm(ltr/min):		
Maximum Pressure:	130psi(9bar)	
Receiver Capacity:	50ltr	
Outlet Fitting:	Quick Release Coupling	
Dimensions (W x D x H):	810 x 420 x 620mm	
Weight:	37kg	

066 PEH2001 Hitablásari 2000W
13A 230V

Tvær stillingar
1000W og 2000W
Hitar 40m³
Hitastillir og vifta líka.

066 PEH3001 Hitablásari 3000W
16A 230V

Tvær stillingar
1500W og 3000W
Hitar 60m³
Hitastillir og vifta líka.

066 FH2010 Hitablásari 2000W
230V

Tvær stillingar
1000W og 2000W
Hitastillir og vifta líka.

066 ADB300 Blásari

Model No:	ADB300	230V
Speeds:	1275rpm	
Maximum Airflow:	10mtr ³ /min (356cfm)	
Power:	96W	
Supply:	230V	
Current:	0.5A	
Weight:	3.7kg	

RAFMAGNSSPIL 12V
066 SRW4300 Spil 12V
4300kg

Model No:	SRW4300
Voltage:	12V
Line Pull*:	4300kg
Motor Power:	1.9kW
Gear Ratio:	196.6:1
Line Speed*:	
No Load:	4.3mtr/min
Maximum Load:	1.6mtr/min
Current Draw:	
No Load:	90A
Maximum Load:	420A
Cable Ø:	9.2mm
Cable Length:	26mtr
Weight:	41.8kg
Replacement Wire Rope:	SRW5450.WR
Dyneema Rope:	SRW5450.DR
Note:	*Performance quoted at first layer of cable on drum



066 TP6818 Olíutunnudæla

Model No:	TP6818
Voltage:	12/230V
Current:	0.4/0.6A
Power:	23W
Duty Cycle:	30min/hr
Flow Rate:	19ltr/min
Fuse:	5A



066 SAC41 Lofthitari og kællir

Model No:	SAC41
Cooler:	70W
Heater:	1000/2000W
Supply:	230V
Anion Density:	2million/cm ³
Maximum Airflow:	350mtr ³ /hr
Cooling Water Tank:	8ltr
Weight:	8kg



**066 PM120L Hræra rafmagns.
120 ltr**

Model No:	PM120L
Motor Power:	1400W
Supply:	230V
No Load Speed:	0-800rpm
Mixing Capacity:	120ltr
Paddle Size:	Ø140mm
Thread:	M14
Weight:	7.5kg



**066 VSCANP Bilanagreinir
SÉRÞÖNTUN**

Model No:	VSCANP
Specification Table:	
Central Processing Unit (CPU):	Intel Quad-Core Processor 1.86GHz
Operating System:	Android 4.4
Hard Drive:	32GB
Touch Screen Display:	8" 1280x800
Wi-Fi:	Yes
Wireless VCI:	Yes
Internal Battery:	3.7V 8500mAh Li-Poly
Weight:	0.70kg
Camera (rear):	5.0 Megapixel
Camera (front):	2.0 Megapixel
Boot-Up Time:	25 Seconds
Auto VIN Recognition:	Some
Subscription Based On-Line Updates:	Yes



Rafmótoralisti



Skeifan 2. 108 Reykjavík. Sími 5305900. www.poulsen.is

Poulsen		Vibratormótorar.		Poulsen	
122 BL03-0,5/4	VIBRATORM. BL 03-0,5/4 4P 490N	100W	380V 50HZ	1440RPM	
122 BL03-1/2	VIBRATORM. BL 03-1/2 2P 981N	120W	380V 50HZ	2880RPM	
122 BL05-1/4	VIBRATORM. BL 05-1/4 4P 981N	175W	380V 50HZ	1440RPM	
122 BL05-2/2	VIBRATORM. BL 05-2/2 2P 1962N	200W	380V 50HZ	2880RPM	
122 BL05-2/4	VIBRATORM. BL 05-2/4 4P 1962N	175W	380V 50HZ	1440RPM	
122 BL15-3/4	VIBRATORM. BL 15-3/4 4P 2993N	300W	380V 50HZ	1440RPM	
122 BL20-5/2	VIBRATORM. BL 20-5/2 2P 4905N	400W	380V 50HZ	2880RPM	

BLZ Range

2 POLE - 2880 / 3456 RPM - 50/60 HERTZ

Blöðun Blade	Blöðun Blade	Blöðun Blade	Blöðun Blade	Blöðun Blade	Blöðun Blade	Blöðun Blade		Blöðun Blade		Blöðun Blade		Blöðun Blade		Blöðun Blade		Blöðun Blade		Blöðun Blade	
						Blöðun Blade	Blöðun Blade	Blöðun Blade	Blöðun Blade	Blöðun Blade	Blöðun Blade	Blöðun Blade	Blöðun Blade	Blöðun Blade	Blöðun Blade	Blöðun Blade	Blöðun Blade	Blöðun Blade	Blöðun Blade
1	1	1	1	1	1	1	1	1	1	1	1	1	1	1	1	1	1	1	1
2	2	2	2	2	2	2	2	2	2	2	2	2	2	2	2	2	2	2	2
3	3	3	3	3	3	3	3	3	3	3	3	3	3	3	3	3	3	3	3
4	4	4	4	4	4	4	4	4	4	4	4	4	4	4	4	4	4	4	4
5	5	5	5	5	5	5	5	5	5	5	5	5	5	5	5	5	5	5	5
6	6	6	6	6	6	6	6	6	6	6	6	6	6	6	6	6	6	6	6
7	7	7	7	7	7	7	7	7	7	7	7	7	7	7	7	7	7	7	7
8	8	8	8	8	8	8	8	8	8	8	8	8	8	8	8	8	8	8	8
9	9	9	9	9	9	9	9	9	9	9	9	9	9	9	9	9	9	9	9
10	10	10	10	10	10	10	10	10	10	10	10	10	10	10	10	10	10	10	10



Ravaglioli

COMPACT WITH QUALITY MANAGEMENT
SYSTEM CERTIFIED BY DNV
= ISO 9001:2008 =

- DUE COLONNE ELETTROIDRAULICI
- ELECTRO-HYDRAULIC 2 POST LIFTS
- ELEKTROHYDRAULISCHE 2-SÄULEN HEBEBÜHNEN
- 2 COLONNES ELECTRO-HYDRAULIQUES
- DOS COLUMNAS ELECTRO-HYDRAULICOS

- KPH 370.32
- 370.42
- 370.40EX
- 370.45EX
- 370.50
- 370.55



10

eco